

USER MANUAL

HEATED CLOTHING

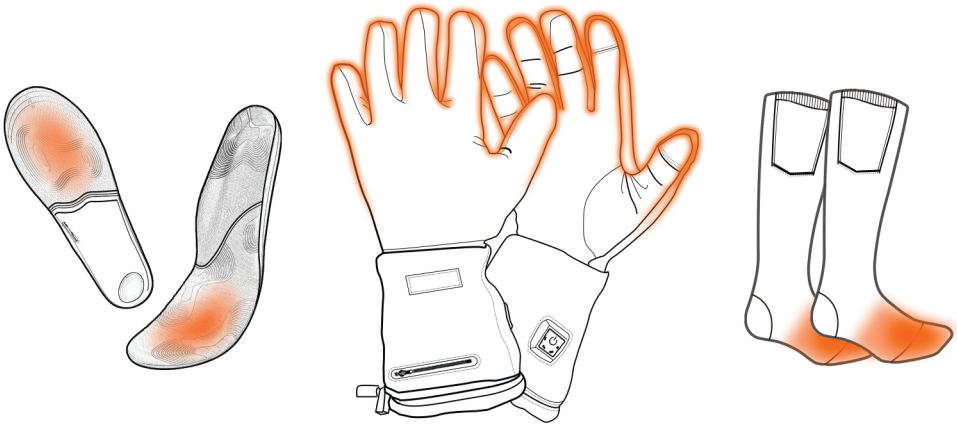

INTRODUCTION

Dear Heated Clothing Purchaser,

We are pleased that you decided to purchase our heated clothing powered by rechargeable lithium batteries.

We hope our advanced heat technology will give you comfortable warm body during hours of cold winter activities.

To make sure that the longevity and the right usage of this product is ensured, please pay attention to this user manual.

Contents

| | | |
|-----------|---|--------------|
| 01 | SAFETY INFORMATION | 01 |
| 02 | HEATED GLOVES | 02 |
| 03 | HEATED SOCKS | 03-07 |
| | • KC-BS001 RC SOCKS | 03 |
| | • KC-BS003 NRC SOCKS | 04-05 |
| | • KC-BS003 APP SOCKS | 06-07 |
| 04 | HEATED INSOLES | 08-14 |
| | • KC-BI006 RC INSOLES | 08 |
| | • KC-BI008 NRC INSOLES | 09 |
| | • KC-BI008 APP INSOLES | 10 |
| | • KC-BI008 WIRELESS CHARGER+NRC INSOLES | 11-12 |
| | • KC-BI008 WIRELESS CHARGER+APP INSOLES | 13 |
| | • KC-BI009 HANGABLE BATTERY INSOLES | 14 |
| 05 | HEATED CLOTHES | 15 |
| 06 | HEATED INDOOR ITEMS | 16-17 |
| | • HEATED GLOVES AND SHOES | 16 |
| | • HEATED BLANKET AND CUSHION | 17 |
| 07 | HEATED ACCESSORIES | 18 |
| 08 | 24V HEATED MASSAGE PAD | 19-20 |

SAFETY INFORMATION

IMPORTANT

Please read all the warnings and cautions carefully before first use.

WARNINGS AND CAUTIONS:

1. Stay alert when using the heated wearing products, do not use the heated wearing products under the influence of drugs, alcohol, or fatigue.
2. The heated wearing products must not be used by:
 - Do not allow children under 6 years or people with cognitive impairment to use the device.
 - People who are sensitive or not sensitive to heat, poor blood circulation, or physical diseases.
3. Do not pull the cable on the heated wearing products. If the cable is broken, please stop using it.
4. If you feel uncomfortable during use, please stop using it immediately.
5. Please keep the heating area smooth during use.
6. Please always turn off the device and disconnect the batteries when it is not in use or under supervision.
7. When cleaning heated wearing products, please put the cable in the pocket or tie it up to avoid mixing with other clothes and damaging the cable.
8. Dry the heated wearing products completely before you can continue to use them.
9. Do not bleach, dry-clean or iron the products.
10. Do not twist the products because it may damage the heating element inside.

HEATED GLOVES

All Models

Operation Steps:

1. Connect: Carefully connect the batteries to the gloves.
2. Turn on/off: Long press the button on the gloves to turn on/off.

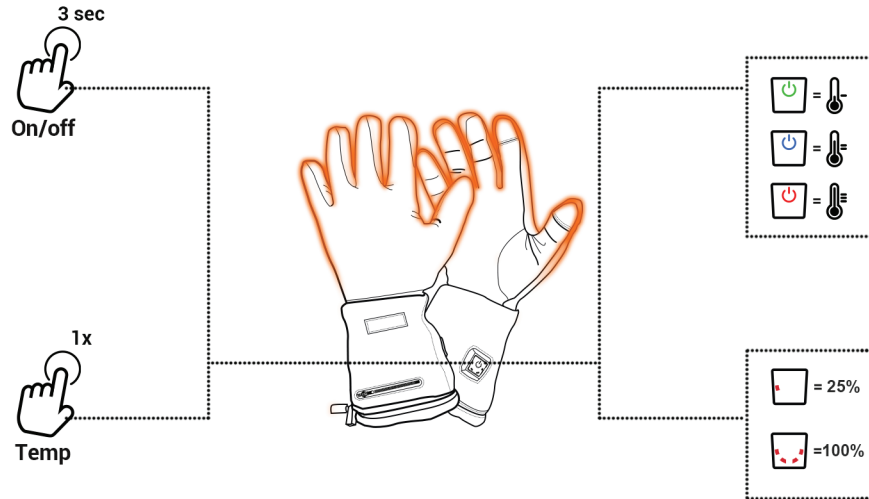

3. Change the heating level: Short press the button for once to change the temperature.
High Level - Red, Med Level - Blue, Low Level - Green
4. Check the remaining battery power: The 4 small lights on the button indicate the remaining battery power.
One light - 25%, Two lights - 50%, Three lights - 75%, Four lights - 100%

Charge the Batteries:

1. Connect: Carefully connect the batteries to the charger.
2. Charging Status: Check the light on the charger. When the batteries are fully charged, the light on the charger changes from red to green.
3. Charging Time: The charging time of an empty battery is generally 4-6 hours.

HEATED SOCKS

KC-BS001 RC SOCKS

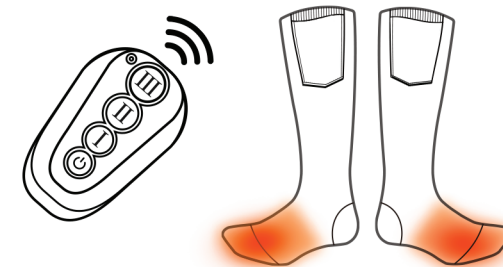

Operation Steps:

Operate by manual:

1. Connection: Carefully connect the power bank to the socks.
2. Turn on/off: Long press the button on the power bank to turn on/off.
3. Change the heating level: Short press the button on the power bank for once to change the temperature.
High Level - Red, Med Level - Blue, Low Level - Green
4. Check the remaining battery power: The 4 small lights on the power bank indicate the remaining battery power.
One light - 25%, Two lights - 50%, Three lights - 75%, Four lights - 100%

Operate by Remote:

1. Pairing: Long press the button on the power bank for 7 seconds. When the indicate light flashes, press any button on the remote to complete the pairing.
2. Turn on/off, change the heating level: Press the corresponding button on the remote.

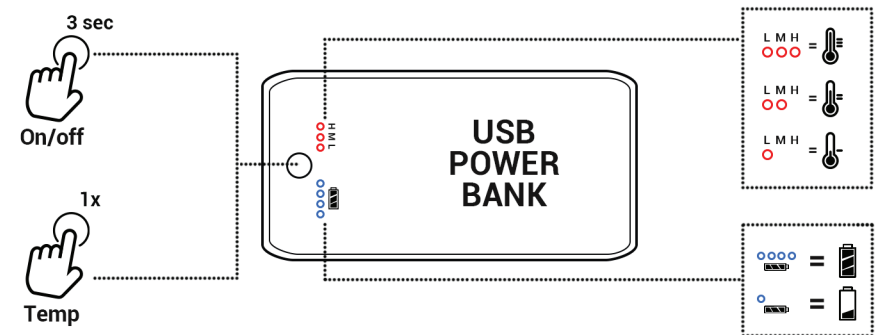

NOTICE

We will pair each remote control with the power bank before shipping, so you could use it directly.

HEATED SOCKS

KC-BS003 NRC SOCKS

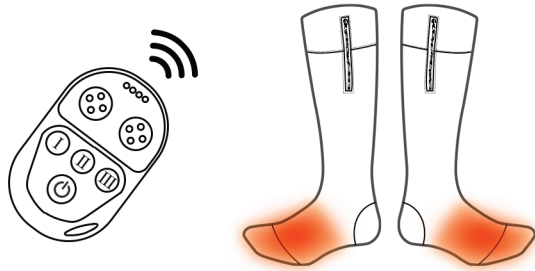

Operation Steps:

Operate by manual:

1. Connection: Carefully connect the power bank to the socks.
2. Turn on/off: Long press the button on the power bank to turn on/off.
3. Change the heating level: Short press the button on the power bank for once to change the temperature.
High Level - Red, Med Level - Blue, Low Level - Green
4. Check the remaining battery power: The 4 small lights on the power bank indicate the remaining battery power.
One light - 25%, Two lights - 50%, Three lights - 75%, Four lights - 100%

Operate by Remote:

1. Pairing: Long press the button on power bank for 7 seconds. When the indicate light flashes, press the button "I" on the remote to complete the pairing of the left side, and press the button "III" on the remote to complete the pairing of the right side.
2. Turn on/off, change the heating level: Press the corresponding button on the remote.

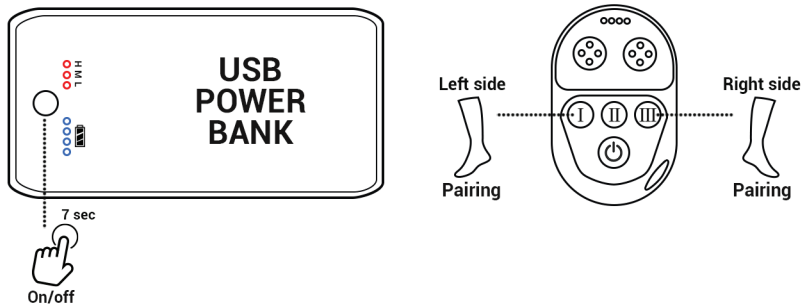

HEATED SOCKS

NOTICE

We will pair each remote control with the power bank before shipping, so you could use it directly.

Introduction of the Remote:

1. The four buttons on the remote represent 3 heating levels and turn on /off.

3. The circle light at the left represents the battery power of the left power bank, and the circle light at the right represents the battery power of the right power bank.

- One light - 25%
- Four lights - 100%

2. The four lights on the top of the remote represent the battery power of the remote.

- One light - 25%
- Four lights - 100%

4. Charge the remote: Connect the remote to the charger, when the 4 lights on the top of the remote stop flashing and all light up, the remote is fully charged.

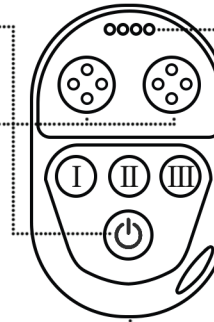

Charge the Power Bank:

1. Connect: Carefully connect the power bank to the charger.
2. Charging Status: Check the lights on the power bank. When the power bank is fully charged, the lights will stop flashing and all light up.
3. Charging Time: The charging time of an empty power bank is generally 4-6 hours.

HEATED SOCKS

KC-BS003 APP SOCKS

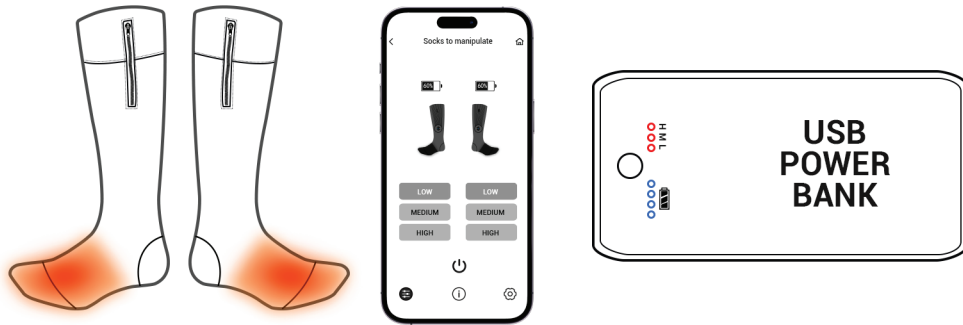

Operation Steps:

Operate by manual:

1. Connection: Carefully connect the power bank to the socks.
2. Turn on/off: Long press the button on the power bank to turn on/off.
3. Change the heating level: Short press the button on the power bank for once to change the temperature.
High Level - Red, Med Level - Yellow, Low Level - Blue
4. Check the remaining battery power: The 4 small lights on the power bank indicate the remaining battery power.
One light - 25%, Two lights - 50%, Three lights - 75%, Four lights - 100%

HEATED SOCKS

Operate by APP

1. Download the APP

- * Open the App Store(iPhone) or Play Store(Android Phone) depending on your device.
- * Search for "KCFIR" and download the app.



Search for "KCFIR"



Download the APP

2. When the power bank is in standby mode, you could change the heating level and turn on/off the device on the APP-SOCKS interface.

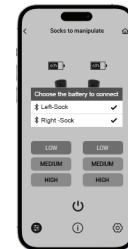

Charge the Power Bank:

1. Connect: Carefully connect the power bank to the charger.
2. Charging Status: Check the lights on the power bank. When the power bank is fully charged, the lights will stop flashing and all light up.
3. Charging Time: The charging time of an empty power bank is generally 4-6 hours.

HEATED INSOLES

KC-BI006 RC INSOLES

Operation Steps:

Operate by manual:

1. Turn on/off: Long press the button on the heel of the insoles to turn on/off.
2. Change the heating level: Short press the button on the heel of the insoles for once to change the temperature.
High Level - Red, Med Level - Blue, Low Level - Green

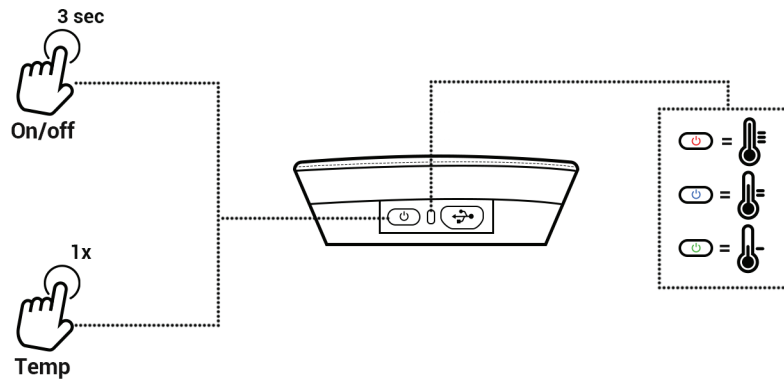
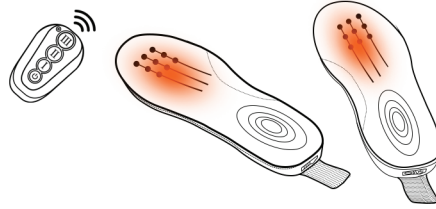

Operate by Remote:

1. Pairing: Long press the button on the heel of the insoles for 7 seconds. When the indicate light flashes, press any button on the remote to complete the pairing.
2. Turn on/off, change the heating level: Press the corresponding button on the remote.

NOTICE

We will pair each remote control with the power bank before shipping, so you could use it directly.

Charge the Insoles:

1. Connect: Carefully connect the insoles to the charger.
2. Charging Status: Check the light on the charger. When the insoles are fully charged, the light on the charger changes from red to green.
3. Charging Time: The charging time of the insoles is generally 4-6 hours.

HEATED INSOLES

KC-BI008 NRC INSOLES

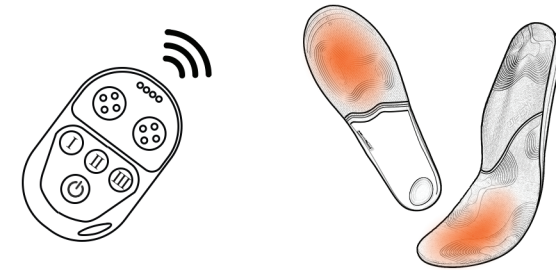

Operation Steps:

Operate by manual:

1. Turn on/off: Long press the button at the inner middle of the insoles to turn on/off.
2. Change the heating level: Short press the button at the inner middle of the insoles for once to change the temperature.
High Level - Red, Med Level - Blue, Low Level - Green

Operate by Remote:

1. Pairing: Long press the button at the inner middle of the insoles for 7 seconds. When the indicate light flashes, press the button "I" on the remote to complete the pairing of the left side, and press the button "II" on the remote to complete the pairing of the right side.
2. Turn on/off, change the heating level: Press the corresponding button on the remote.

NOTICE

We will pair each remote control with the insoles before shipping, so you could use it directly.

Charge the Insoles:

1. Connect: Carefully connect the insoles to the charger.
2. Charging Status: Check the light on the charger. When the insoles are fully charged, the light on the charger changes from red to green.
3. Charging Time: The charging time of the insoles is generally 4-6 hours.

HEATED INSOLES

KC-BI008 APP INSOLES



Operation Steps:

Operate by manual:

1. Turn on/off: Long press the button at the inner middle of the insoles to turn on/off.
2. Change the heating level: Short press the button at the inner middle of the insoles for once to change the temperature.
High Level - Red, Med Level - Yellow, Low Level - Blue

Operate by APP:
Please refer to page 07.

Charge the Power Bank:

1. Connect: Carefully connect the insoles to the charger.
2. Charging Status: Check the LED lights at the inner middle of the insoles.
When the red light flashes, it means that the battery power is 0-33%.
When the yellow light flashes, it means that the battery power is 34%-66%.
When the blue light flashes, it means that the battery power is 67%-99%.
When the light stop flashing and the blue light is on, it means that the insoles are fully charged.
3. Charging Time: The charging time of the insoles is generally 4-6 hours.

HEATED INSOLES

KC-BI008 WIRELESS CHARGER + NRC INSOLES

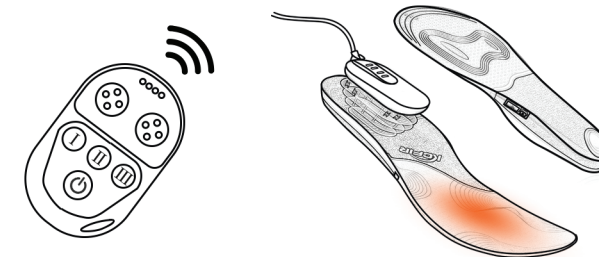

Operation Steps:

Operate by manual:

1. Turn on/off: Long press the button at the inner middle of the insoles to turn on/off.
2. Change the heating level: Short press the button at the inner middle of the insoles for once to change the temperature.
High Level - Red, Med Level - Blue, Low Level - Green

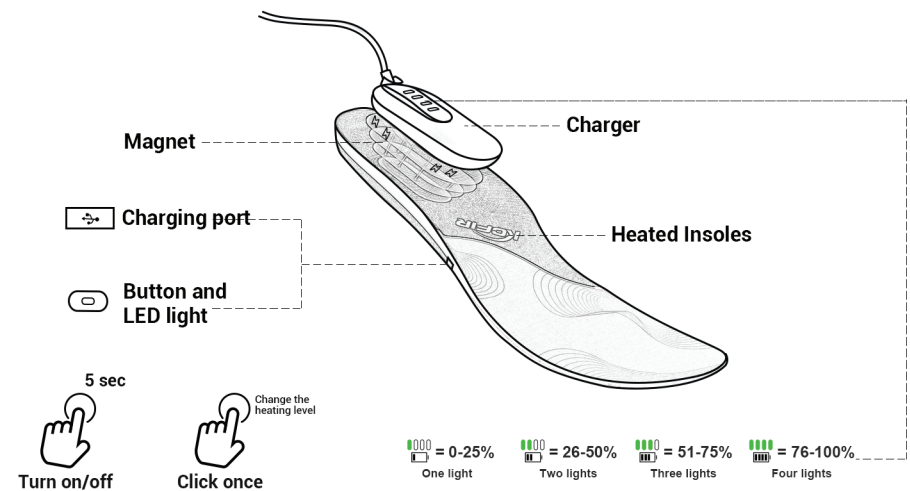

HEATED INSOLES

Operate by Remote:

1. Pairing: Long press the button at the inner middle of the insoles for 7 seconds. When the indicate light flashes, press the button “ I ” on the remote to complete the pairing of the left side, and press the button “ IIII ” on the remote to complete the pairing of the right side.
2. Turn on/off, change the heating level: Press the corresponding button on the remote.

NOTICE

We will pair each remote control with the power bank before shipping, so you could use it directly.

Charge the Insoles:

Wireless Charging:

1. The wireless charger can charge both the insoles and the remote at the same time.
2. Put the wireless charging boards with LED lights on the heel of the insoles, when the lights on the charging board flashes, it means that the insoles enter the charging state.
3. Put the remote on another charging board without LED lights, when the lights on the remote flashes, it means that the remote enters the charging state.
4. When the LED lights stop flashing and all light up, it means that the insoles and the remote are fully charged.

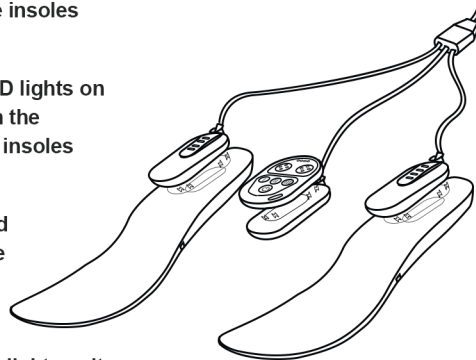

Alternative Charging Method:

The insoles can be charged by 5V TYPE-C charger.

1. Connect: Carefully connect the insoles to the charger.
2. Charging Status: Check the LED lights at the inner middle of the insoles.
When the red light flashes, it means that the battery power is 0-33%.
When the blue light flashes, it means that the battery power is 34%-66%.
When the green light flashes, it means that the battery power is 67%-99%.
When the light stop flashing and the green light is on, it means that the insoles are fully charged.
3. Charging Time: The charging time of the insoles is generally 4-6 hours.

HEATED INSOLES

KC-BI008 WIRELESS CHARGER + APP INSOLES

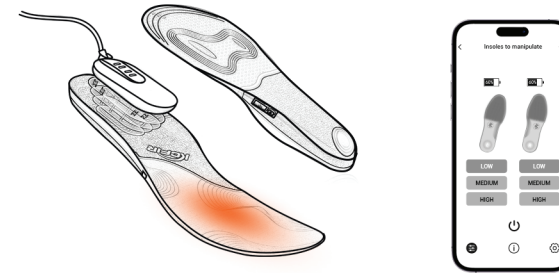

Operation Steps:

Operate by manual:

1. Turn on/off: Long press the button at the inner middle of the insoles to turn on/off.
2. Change the heating level: Short press the button at the inner middle of the insoles for once to change the temperature.
High Level - Red, Med Level - Yellow, Low Level - Blue

Operate by APP: Please refer to page 07.

Charge the Insoles:

Wireless Charging:

1. Put the wireless charging boards with LED lights on the heel of the insoles, when the lights on the charging board flashes, it means that the insoles enter the charging state.
2. When the LED lights stop flashing and all light up, it means that the insoles are fully charged.

Alternative Charging Method: Please refer to page 12.

HEATED INSOLES

KC-BI009 HANGABLE BATTERY INSOLES

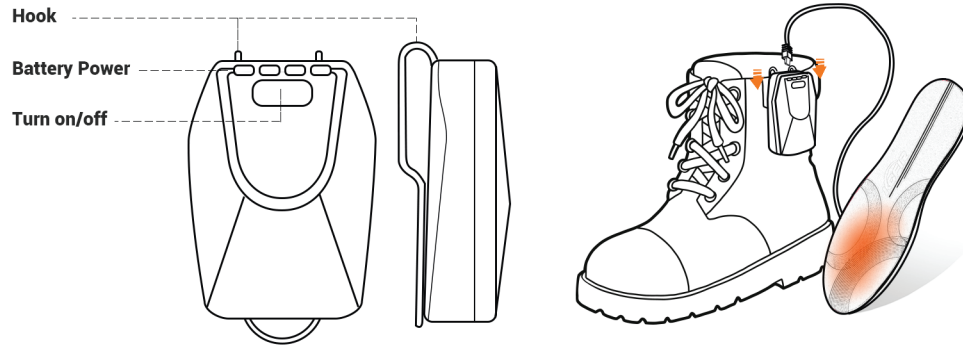

Install the Batteries:

1. The four indicator lights on the battery represent the battery power.
2. Connect the batteries to the insoles.
3. Hang the batteries on the boots.

Operation Steps:

Operate by manual:

1. Turn on/off: Long press the button on the batteries to turn on/off.
2. Change the heating level: Short press the button on the batteries for once to change the temperature.
High Level - Red, Med Level - Yellow, Low Level - Blue

Operate by APP:
Please refer to page 07.

Charge the Batteries:

1. Connect: Carefully connect the batteries to the charger.
2. Charging Status: Check the light on the charger. When the batteries are fully charged, the light on the charger changes from red to green.
3. Charging Time: The charging time of the insoles is generally 4-6 hours.

HEATED CLOTHES

ALL MODELS

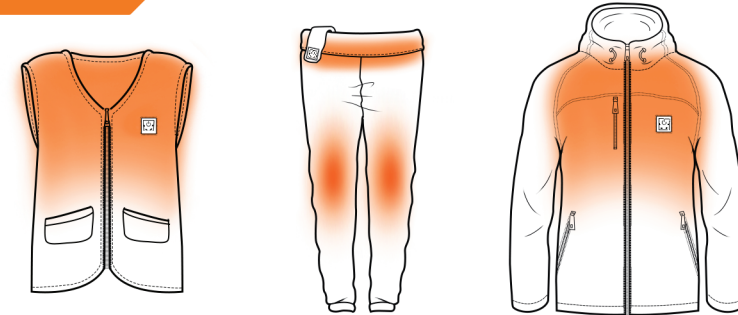

Operation Steps:

Operate by manual:

1. Connect: Carefully connect the battery to the garment.
2. Turn on/off: Long press the button on the garment to turn on/off.

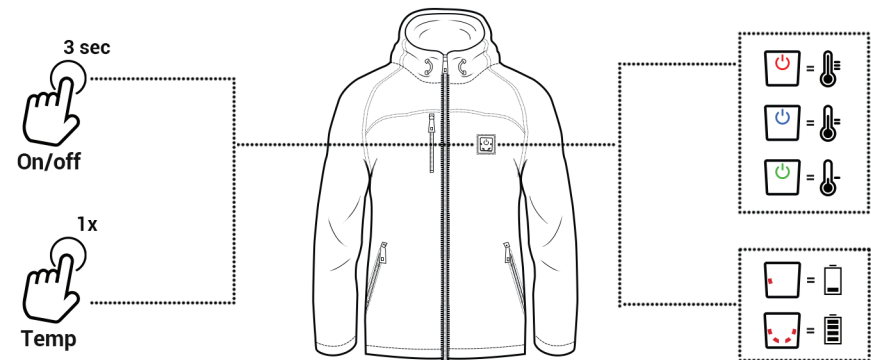

3. Change the heating level: Short press the button for once to change the temperature.
High Level - Red, Med Level - Blue, Low Level - Green
4. Check the remaining battery power: The 4 small lights on the button indicate the remaining battery power.
One light - 25%, Two lights - 50%, Three lights - 75%, Four lights - 100%

Charge the Battery:

1. Connect: Carefully connect the battery to the charger.
2. Charging Status: Check the light on the charger. When the batteries are fully charged, the light on the charger changes from red to green.
3. Charging Time: The charging time of an empty battery is generally 4-6 hours.

HEATED INDOOR ITEMS

KC-HIG001 HEATED GLOVES / KC-HIS001 HEATED SHOES

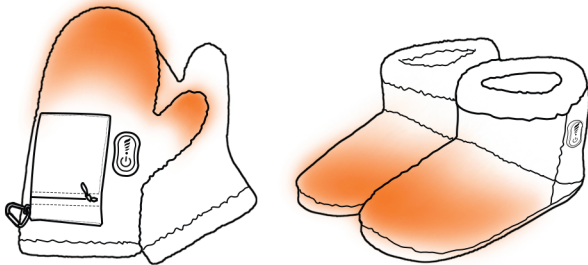

Operation Steps:

Operate by manual:

1. **Connect:** Carefully connect the batteries to the gloves/shoes.
2. **Turn on/off:** Long press the button on the gloves/shoes to turn on/off.
3. **Change the heating level:** Short press the button for once to change the temperature.



High Level - Red Med Level - Blue Low Level - Green

4. **Check the remaining battery power:** The 4 small lights on the button indicate the remaining battery power.



5. **Turn on/off the lights:** Press the dot icon on the button for once to turn on/off the LED light display.

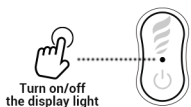

Turn on/off the display light

Charge the Battery:

1. **Connect:** Carefully connect the batteries to the charger.
2. **Charging Status:** Check the light on the charger. When the batteries are fully charged, the light on the charger changes from red to green.
3. **Charging Time:** The charging time of an empty battery is generally 4-5 hours.

5V HEATED INDOOR ITEMS

KC-HIB001 5V HEATED BLANKET / KC-HIC001 5V HEATED CUSHION

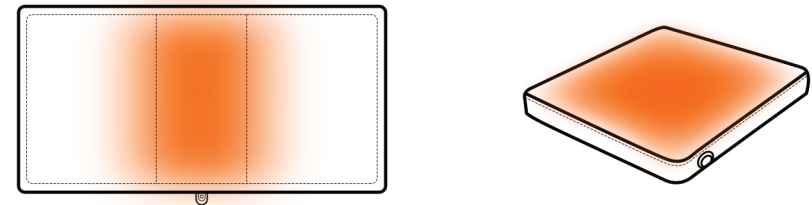

Operation Steps:

1. **Connect:** Carefully connect the power bank to the blanket/cushion.
2. **Turn on/off:** Long press the button on the blanket/cushion to turn on/off.
3. **Change the heating level:** Short press the button for once to change the temperature. High Level - Red, Med Level - Blue, Low Level - Green
4. **Check the remaining battery power:** The 4 small lights on the power bank indicate the remaining battery power. One light - 25%, Two lights - 50%, Three lights - 75%, Four lights - 100%

Charge the Power Bank:

1. **Connect:** Carefully connect the power bank to the charger.
2. **Charging Status:** Check the lights on the power bank. When the power bank is fully charged, the lights will stop flashing and all light up.
3. **Charging Time:** The charging time of an empty power bank is generally 3-4 hours.

HEATED ACCESSORIES (HAT/SCARF/MUFF)

HEATED ACCESSORIES

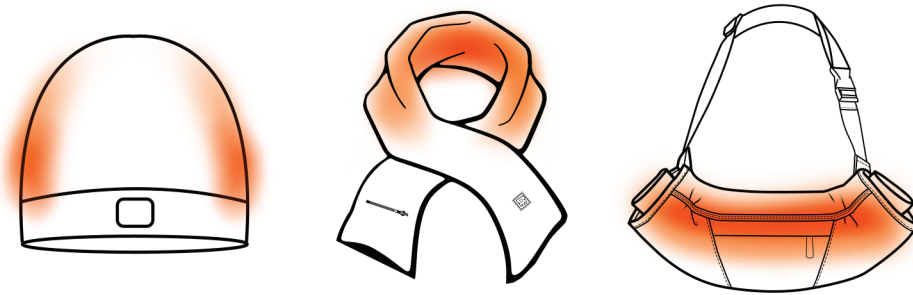

Operation Steps:

1. Connect: Carefully connect the battery to the hat/scarf/muff.
2. Turn on/off: Long press the button on the hat/scarf/muff to turn on/off.
3. Change the heating level: Short press the button for once to change the temperature. High Level - Red, Med Level - Blue, Low Level - Green
4. Check the remaining battery power: The 4 small lights on the button indicate the remaining battery power. One light - 25%, Two lights - 50%, Three lights - 75%, Four lights - 100%

Charge the Batteries:

1. Connect: Carefully connect the battery to the charger.
2. Charging Status: Check the light on the charger. When the battery is fully charged, the light on the charger changes from red to green.
3. Charging Time: The charging time of an empty battery is generally 3-4 hours.

24V HEATED MASSAGE PAD

HEATED MASSAGE PAD

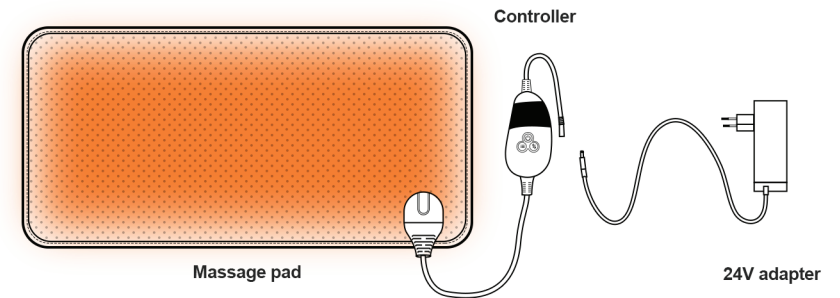

Operation Steps:

1. Connect the controller to the connection port of the massage pad.
2. Connect the other end of the controller to the 24V adapter.
3. Connect the 24V adapter to the wall socket.
4. To turn the massage pad on/off: press Turn on/off-Button once.
5. To choose the mode: press the Menu-Button once.
6. To change the heating level/massage level/timer setting: press the Arrow-Button once.
7. To cancel the heating /massage/timer function: press the Arrow-Button until the LED icon goes off.

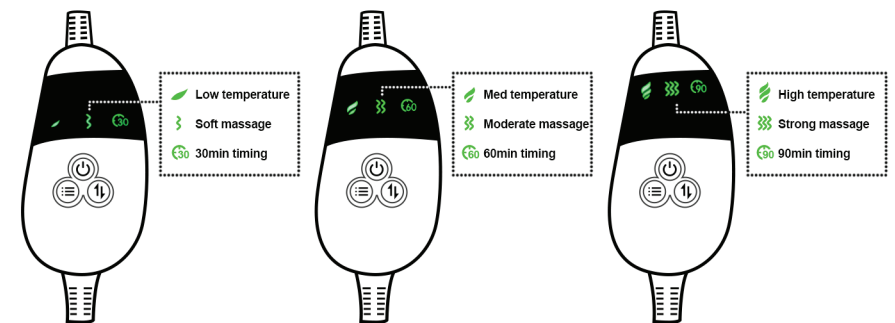

24V HEATED MASSAGE PAD

HEATED MASSAGE PAD

AUTO-OFF FUNCTION:

The 24V message pad has the function of timing, please follow the steps to time your massage pad.

1. Turn on the heating pad.
2. Press the Menu-Button to choose the timer function.
3. Press the Arrow-Button to set the time, 30min/60min/90min.

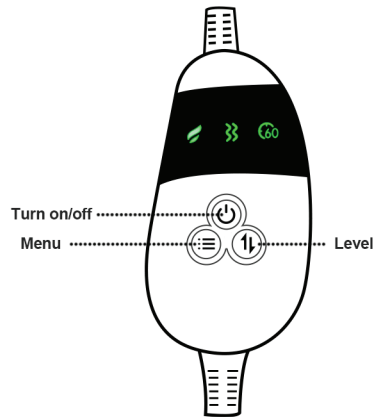

⚠ NOTICE

There are three modes to choose from for heating, massage and timer, you could set the heating/massage level and time according to the light displayed on the screen.

***Thank you for your
patience to read our user manual!***

If you encounter any questions and couldn't find the answer in the manual, please contact our customer email: sales@kcfir.com