

# zappi

eco-smart EV charge point



## Operation & Installation Manual

### MODELS:

ZAPPI-207UW	ZAPPI-207UB
ZAPPI-207TW	ZAPPI-207TB
ZAPPI-222UW	ZAPPI-222TW
ZAPPI-222UB	ZAPPI-222TB



Rev 1.1 July 2019 - ENGLISH

---

## Contents

Introduction.....	3
Safety.....	3
Box Contents.....	4
Overview.....	4
Operation.....	6
Controls & Indicators.....	6
Display.....	7
Status Screens.....	9
Charging Modes.....	11
Manual Boost.....	11
Smart Boost.....	12
Boost Timer.....	14
Lock Function.....	15
Menus.....	16
Main Menu.....	16
Advanced Menu.....	19
Configuration Settings.....	20
Advanced Settings.....	20
eSense.....	23
Linking Devices.....	24
Installation.....	27
Electrical Installation.....	29
Wiring.....	30
eSense Input (economy tariff).....	31
Fitting the Cover.....	36
Advanced Installation Options.....	37
Built-in Protection.....	39
RCD Protection.....	39
Loss of PEN Conductor.....	39
Welded Contact.....	39
Over-current.....	39
Over and Under-voltage.....	39
Thermal Limit.....	40
Setup.....	40
Troubleshooting.....	41
Faults.....	42
Warranty.....	43
Product Registration.....	43
Technical Specifications.....	44
The myenergi app.....	46
The myenergi forum.....	46
Technical Support.....	46
My Devices.....	47

## Introduction

Thank you for choosing zappi. Of course, we think you have made an excellent choice and are sure you will be very happy with the features, benefits and quality of this myenergi product.

These instructions will help you to familiarise yourself with the zappi, by reading the instructions, you will be sure to get the maximum benefit from this 'eco-smart' device.

## Safety

The device has been manufactured in accordance with the state of the art and the recognised safety standards. However, incorrect operation or misuse may result in:

- ⚠ Injury or death to the operator or third parties
- ⚠ Damage to the device and other property of the operator
- ⚠ Inefficient operation of the device

All persons involved in commissioning, maintaining and servicing the device must:

- ⚠ Be suitably qualified
- ⚠ Have knowledge of and experience in dealing with electrical installations
- ⚠ Read and follow these operating instructions carefully
- ⚠ Always disconnect the device from the supply before removing the cover

The device is not to be used by persons (including children) with reduced physical, sensory or mental capabilities, or lack of experience and knowledge, unless they have been given supervision or instruction concerning use of the device by a person responsible for their safety.

Failure to install and operate the zappi in accordance with these instructions may damage the unit and invalidate the manufacturer's warranty.



In accordance with European Directive 2002/96/EC on waste electrical and electronic equipment and its implementation in national law, used electrical devices **must** be collected separately and recycled in an environmentally responsible manner. Ensure that you return your used device to your dealer or obtain information regarding a local, authorised collection and disposal system. Failure to comply with this EU Directive may result in a negative impact on the environment.

## Copyright

Copyright of these operating instructions remains with the manufacturer. Text and images correspond to the technical level at the time of going to press. We reserve the right to make changes. The content of the operating instructions shall not give rise to any claims on the part of the purchaser. We are grateful for any suggestions for improvement and notices of errors in the operating instructions.

myenergi zappi, myenergi eddi, myenergi harvi and myenergi hub are registered trademarks of myenergi Ltd.

## Box Contents

### Tethered units

1 x zoppi unit with EV cable and connector attached.  
1 x Cable wall guard  
1 or 3 x CT Clamps – (1 x single phase units / 3 x three-phase units).  
1 x Mounting template.  
1 x Mounting kit for a brick wall.

### Mounting kit (Tethered units)

4 x 50mm Pozi screws  
4 x Wall mounting plug  
4 x Sealing washer  
4 x 12mm Pozi screws (countersunk)

### Untethered units

1 x zoppi unit.  
1 or 3 x CT Clamps – (1 x single phase units / 3 x three-phase units).  
1 x Mounting template.  
1 x Mounting kit for a brick wall.

### Mounting kit (Untethered units)

4 x 50mm Pozi screws  
4 x Wall mounting plug  
4 x Sealing washer

## Overview

Microgeneration systems such as Solar PV and small wind turbines are at their most efficient when the generated energy is consumed on-site rather than exporting it to the grid. This is what we call 'self-consumption'.

zoppi is a Mode 3 charging station, compatible with all electric vehicles that comply with EN 62196 and EN 61851-1 plug-in electric vehicle standards.

zoppi works like any regular charging point but has special ECO charging modes that will benefit homeowners with grid-tied microgeneration systems e.g. wind or solar generation. Two special ECO charging modes automatically adjust charging current in response to on-site generation and household power consumption. In FAST charge mode, zoppi operates like an ordinary EV charger.

A grid current sensor (**supplied**) simply clips around the incoming supply cable. this sensor is used to monitor excess power and when using the special ECO charge modes, zoppi will automatically adjust the charge rate in response to available surplus.

## Feature Set

- 3 charging modes: ECO, ECO+ & FAST
- Optimises microgeneration self-consumption
- Works with solar PV, wind turbine or micro-hydro systems
- Economy tariff sense input
- Programmable timer function
- Charge and event logging
- Remote control and monitoring add-on option
- Pin-code lock function
- Tap operated display backlight
- Built-in 30mA Type A RCD protection (EN 61008) + 6mA DC RCD protection (EN 62955)
- Built in protection against the loss of the protective neutral and earth (PEN) conductor as required by BS 7671:2018 (The “Wiring Regulations”)
- Integral cable holster (tethered units)
- Supplied with 1 x clip-on grid current sensor (x 3 if purchasing a 3 phase unit)
- Illuminated display – for convenience the display can be illuminated by simply tapping the zoppi front cover

## Overview Diagram

The diagram opposite, shows the zoppi as part of a complete energy management system. Other myenergi products are shown and how they integrate with the grid connection and the microgeneration system.

Overview Diagram

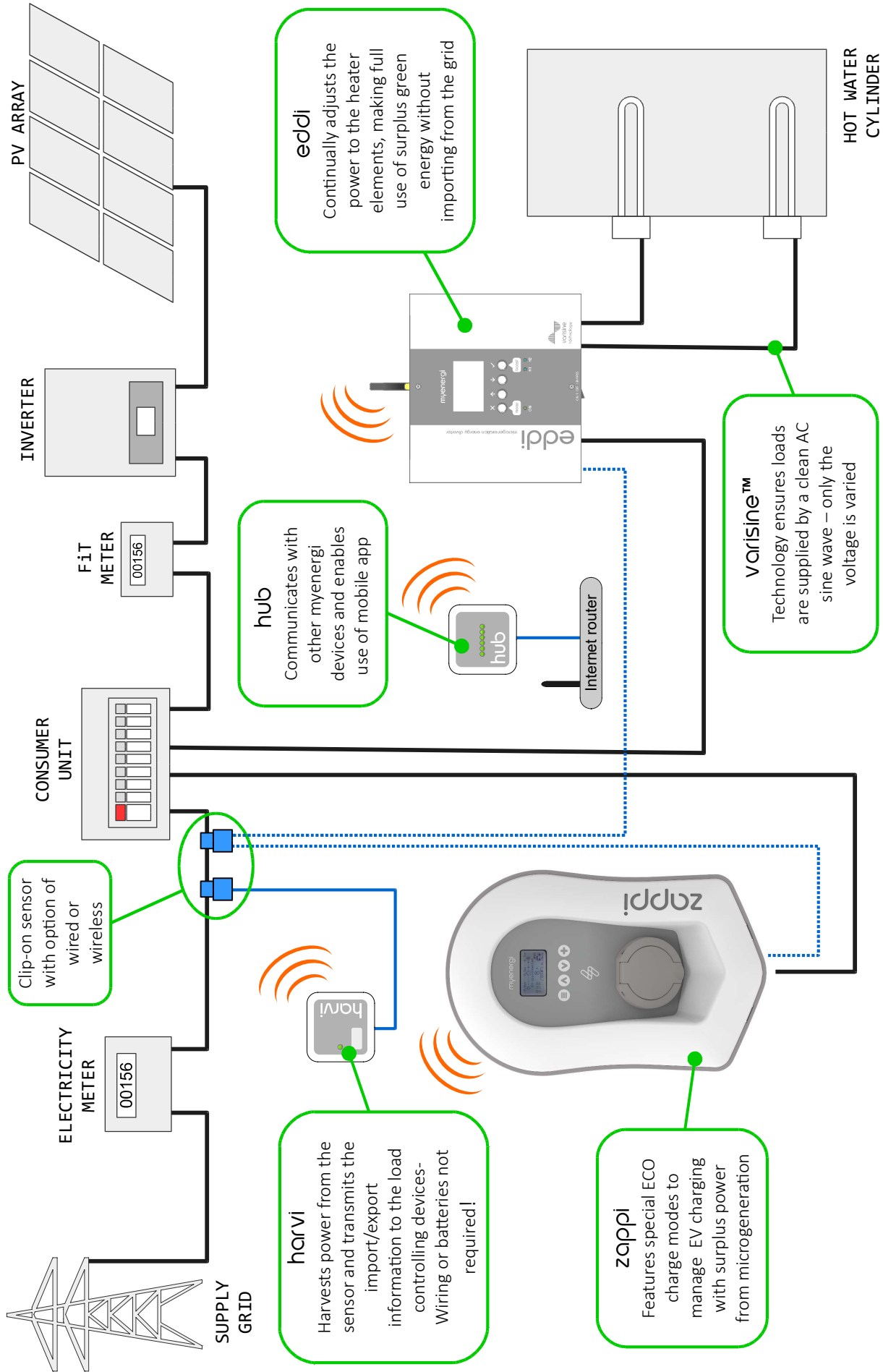

## Operation

### Controls & Indicators







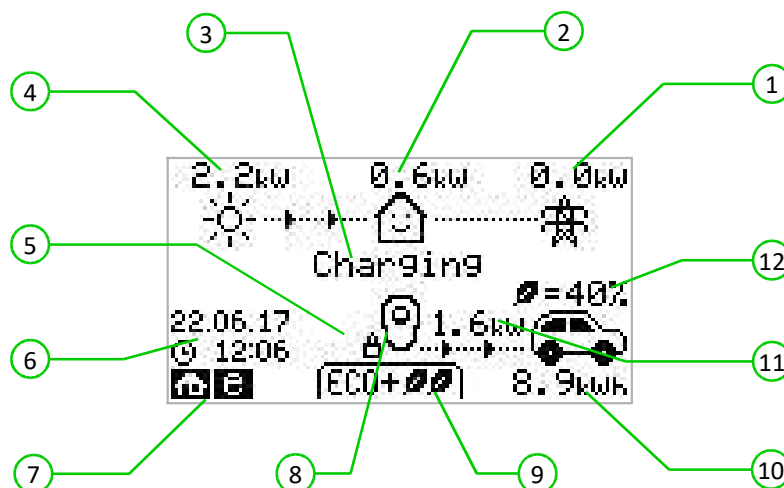









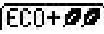



①	Display	Graphical LCD display with LED backlight <ul style="list-style-type: none"><li>Backlight can be activated by tapping the unit.</li></ul>
②	Front fascia	Removable fascia for installing and servicing.
③	Tethered Charging Cable if applicable	6.5 meter cable with a Type 2 plug or Type 2 socket with locking system for non tethered models.
④	Control Buttons	Four tactile buttons used to navigate the menus and alter settings: ☰ Menu ⬆ Change charge mode   Move up a menu item   Increase value. ⬇ Change charge mode   Move down a menu item   Decrease value. ⊕ Boost   Select item   Confirm value and move to next setting.
⑤	Integrated Cable Holster (tethered units only)	When not in use, the charging cable should be wrapped around the unit's cable holster (tethered units).
⑥	Charging Connection Point (non tethered units)	When cable not use, the charging cable should be unplugged and stored in a cool dry place.
⑦	RGB Indicator	Visual Indicator that changes colour dependant on the <i>zappi's</i> charging state. (see RGB Indicator page 8)

## Display



<p>① Import / Export Power</p>	<p>The power being either imported or exported from or to the grid (kW). The direction of the arrows indicate if the property is currently importing power (left) or exporting power (right)</p> <p>The size of the arrows is proportionate to the level of power being imported / exported, When the property is neither importing or exporting power the figure will be 0.0kW and there will no animated arrows. The property is then said to be 'in balance'</p>
<p>② House Load Power</p>	<p>The power that the property is currently using in kW</p> <p><i>Note: This is displayed only when the Generation Sensor is installed directly to a CT input or a harvi or other myenergi device)</i></p>
<p>③ Status Text</p>	<p>The current status is displayed here (see <i>Status Screens</i> page 9)</p>
<p>④ Generation Power</p>	<p>The power being generated at this time in kW.</p> <p><i>Note: This is displayed only when the CT'S are installed either hard wired to the CT inputs of the zappi or wirelessly to a harvi or other myenergi device)</i></p>
<p>⑤ Lock Icon</p>	<p>Operation lock is active.</p>
<p>⑥ Date &amp; Time</p>	<p>The current date and time.</p>
<p>⑦ Mode Icons</p>	<p>These icons indicate that the import limiting is active (house) or the e-Sense input is live (e) see <i>page 22</i></p>
<p>⑧ zappi Icon</p>	<p>If you see wavy lines above the <i>zappi</i> icon, the unit is thermally limiting! The output power is temporarily reduced.</p>
<p>⑨ Charge Mode</p>	<p>Shows the selected Charging Mode; FAST, ECO or ECO+ (see <i>Charging Modes</i> page 11)</p>
<p>⑩ Charge Delivered to EV</p>	<p>The accumulated charge energy that has been sent to EV in this charge session.</p>
<p>⑪ Current Charging Power</p>	<p>When the EV is charging, arrows will show here along with the charging power in kW</p>
<p>⑫ Green Level of last charge</p>	<p>This is percentage of 'Green' energy for the last charge session, this is shown at the end of a charge or when the EV is unplugged</p>

## Display Icons Key

	House Consumption – Not Importing		Charge Mode = FAST
	House Consumption – Importing		Charge Mode = ECO
	Solar Generation Power		Charge Mode = ECO+
	Wind Generation Power		zappi Device – Normal On the three phase zappi the number in the icon indicates whether the EV is charging with a single phase or all three phases.
	Grid Power – Import / Export		zappi Device – Too Warm (output limited) Number indicates single or three phase charging
	Power Flow Direction – Small Amount		Import Power Limiting Active
	Power Flow Direction – Medium Amount		Economy Tariff Electricity Available
	Power Flow Direction – Large Amount		Current Charging Power
	Waiting For Surplus Power		Energy sent to EV for this charge
	DSR Mode (demand side response) <sup>1</sup>		Warning – refer to text on screen

## RGB Indicator

The lightning flash indicator on the front of the zappi indicates the status of the charge:

Pink:	Connected
Green:	Charging 100% Green
White:	Charging from Grid Only
Yellow:	Charging mix of grid/green energy
Blue:	Charge complete
Red:	Error

The colour effect (variation of the brightness) speeds up according to the charging power.

<sup>1</sup> DSR – Demand Side Response – A smart feature for future use by electricity suppliers and distribution companies to help manage load on the electricity system at times of high demand. This feature can only be enabled by the owner of the zappi.



## Status Screens

### EV Disconnected



The EV is not connected to zappi

In this example the last charging session delivered 20.8kWh of energy to the EV and 80% of that energy came from the solar panels.

### Waiting for Surplus...



zappi is waiting for sufficient surplus power from the microgeneration system. This screen will be shown in ECO+ mode as it's only in this mode that charging will stop if there is not enough surplus power.

The house in the centre is straight-faced as grid electricity is being used by the house (0.9kW is this example).

### Waiting for EV...



zappi is waiting for the EV to respond; the EV is not ready to accept charge.

### Charge Delayed

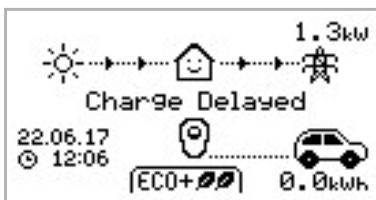

The charging session has been delayed by the EV because a scheduled charge has been set in the vehicle.

### Paused...



zappi is paused for a few seconds in order to limit the start/stop frequency during ECO+ mode charging.

# Operation

## Charging

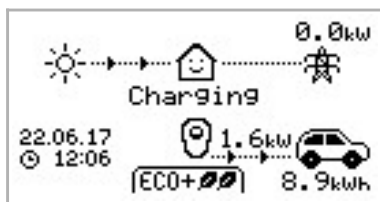

The EV is charging.

In this example the car is charging in ECO+ mode at 1.6kW, there is no import or export from the grid (0.0kW) and the EV battery has charged by 8.9kWh since the car started.

## Charge Complete



The EV is fully charged.

The charge energy used during the last charge is displayed at the bottom right (20.0kWh in this case) and the 'green contribution' is also shown (40% in this example).

## Restart...



zappi is doing a restart sequence.

This may happen with some EVs that need to be 'woken-up' to start charging after a pause in the charge. Charge should start immediately afterwards, otherwise the "Charge Delayed" message will appear.

## Stopping...



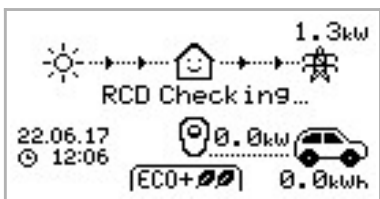

Zappi is about to stop the EV charging

## Checking...



zappi is carrying out a check to make sure that the built in RCD and "PEN Fault" protection is working before starting to charge the car. zappi carries out this before every charge so there is no need to manually test the RCD protection.

## Charging Modes

zappi has three different charging modes which can be selected simply by pressing the  and  buttons when the main screen is showing. The charge mode can be changed before or during a charge.



Regardless of the charge mode used, all of the surplus electricity is used but zappi's special eco charge modes limit the amount of grid electric used. Below is explanation of each of the three charging modes.

### **Charges at the fastest rate.**

Fast Mode will charge the EV at the fastest rate and will import grid electricity if there is insufficient surplus generated power.

The actual charge rate is dependant on the EV's onboard charger and the grid supply voltage although some vehicles can charge at 11kW or 22kW on a 3-Phase zappi, many EV's have lower charge rates, the maximum charge rate for the single phase zappi is 7kW.

The actual power can vary if the grid supply voltage is not exactly 230V.

### **Adjusts the charge rate to limit the use of grid electricity.**

The charge rate is continuously adjusted, in response to changes in generation or power consumption elsewhere in the home, thereby minimising the use of grid power.

Charging will continue until the vehicle is fully charged, using available surplus power.

However, if at any time, the available surplus power falls below 1.4kW, the shortfall will be drawn from the grid.

*Note: The EV charging standard does not support charging below 1.4kW.*

### **Adjusts the charge rate to limit the use of grid electricity and will pause the charge if there is too much or any grid electricity being used (setup dependant)**

The charge rate is continuously adjusted, in response to changes in generation or power consumption elsewhere in the home, thereby minimising the use of grid power. Charging will pause if there is too much imported power, continuing only when there is enough surplus power available. The surplus power threshold at which the charge will start or stop can be set using **Min Green Level** in the **ECO+ Settings** of the **Charge Settings** menu.

The actual green contribution percentage is shown when the charge is complete or when the zappi has been disconnected from the EV.

It is possible to charge the EV using only surplus renewable power, providing there is sufficient surplus power available and a boost option has **not** been set. *(Please note: The EV charging standard does not support charging below 1.4kW)*

*example: when zappi is set to a Min Green Level of 100% you will need in excess of 1.4kw (approx) of surplus energy available to start the charge, if the surplus falls below the 1.4kw threshold the charge will pause until the threshold is once again met, after a short delay zappi will resume charge.*

*You can if preferable set the zappi to share power from the grid and generation source to ensure a charge is always maintained, e.g. Min Green Level could be set to 75% (using mostly surplus but will use a little grid if needed).*

## Manual Boost

The Manual Boost function can only be used when charging in ECO or ECO+ mode. When boosting, the charge rate is set to maximum (just like FAST mode), until a set amount of energy has been stored in the EV's battery. After which, zappi will revert back to ECO or ECO+ mode.

This function is useful if you arrive home with an almost flat battery and would like to charge the vehicle immediately to ensure there is enough charge for a short trip if needed.

# Operation

---

The amount of energy boost uses can be changed in the **Charge Settings/Boost** menu.

When in ECO or ECO+ mode, each press of the **+** button will cycle through the boost options as illustrated below:

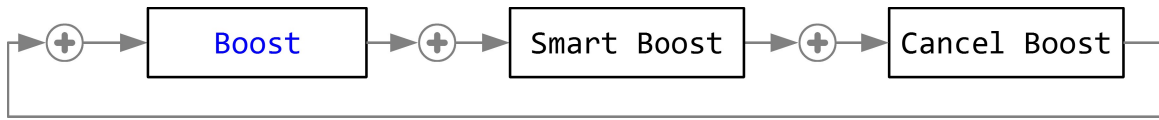

## Activating Boost

---

1. When charging in ECO or ECO+ mode, press **+** until **BOOST** is shown.
2. The boost will start after a couple of seconds and the display will show the remaining boost energy.

The boost duration can be altered in the **Charge Settings/Manual Boost** menu option.

## Cancelling Boost

---

The boost can be cancelled by pressing **+** until **Cancel Boost** is shown.

## Smart Boost

The Smart Boost function will charge the EV with a minimum kWh figure by a set time. Smart Boost is available only in ECO and ECO+ modes.

- ⚠ The Smart Boost function does not bring the battery to a certain state of charge. The target kWh is only the energy added during the charging session.

When in ECO or ECO+ mode, each press of the **+** button will cycle through the boost options as illustrated below:

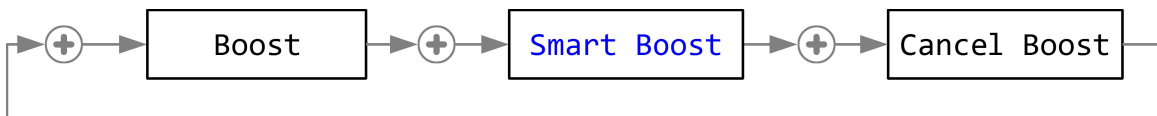

Example: It's a sunny Sunday and you wish to ensure there is enough charge in the EV to get to work in the morning (e.g. 15kWh), but in the meantime, you want to use the surplus energy from the PV system to charge the car, so you choose to use ECO+ mode. At sunset there was only 10kWh of charge accumulated. However, because you activated **Smart Boost**, and set the time you needed to leave for work, zappi automatically boosted the charge in the night to top up the battery to the required 15kWh by 7am.

## Activating Smart Boost

1. When charging in ECO or ECO+ mode, press  until SMART BOOST is shown.

2. The SMART BOOST icon will show including the target time and the pre-set energy amount (7.00am and 17kWh respectively, in this example screen shot).

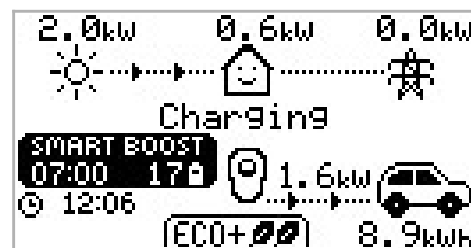

3. zappi will then test the EV for a few seconds, to determine the maximum charge rate.

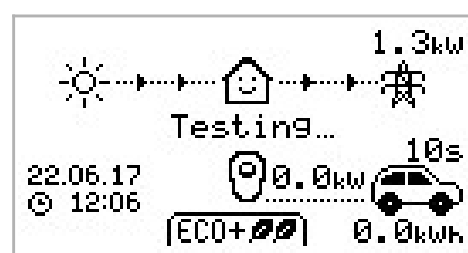





4. The boost will start at the latest possible time to achieve the set energy amount, if the current charge session has already accumulated enough energy, the boost will not be required and so will not operate.

The required energy and target time can be altered only when Smart Boost is not active. These settings are in the Charge Settings/Smart Boost menu option.

## Cancelling Boost

The boost can be cancelled by pressing  until Cancel Boost is shown.

## Programming the Smart Boost Values













1. From the main screen, press  to enter Main Menu
2. Select Smart Boost from within the Charge Settings menu. The SMART BOOST screen is then shown.
3. The boost can now be edited: Use  or  buttons to edit the target time and amount of charge (kWh) that is required
4. Use the  to move to the next value, and the  to return to the main screen once the required Smart Boost parameters have been set.

## Boost Timer

When using ECO or ECO+ charge modes, zappi can be programmed to 'boost' the current charge at certain times. When boosting, the charge rate is set to maximum (just like FAST mode), regardless of the amount of available surplus power. This means that power may be drawn from the mains grid supply during boost times.

- There are four editable time slots which can be set to operate for certain days of the week.
- Setting the duration to 0h00 will make the boost inactive.

## Programming Boost Times

1. From the main screen, press  to enter Main Menu
2. Select Boost Timer from within the Charge Settings menu. The BOOST TIMER screen is then shown.
3. The boost can now be edited: Use  or  buttons to highlight the time slot you wish to change. The screen below shows the start hour being edited:
4. Alter the start hour with the  or  buttons and then press  to move to minutes.
5. Edit the duration in the same way and then press  again to edit the days of the week you want the boost to be active for; each day of the week and by toggled on/off with  or  buttons, press  to go to the next day. Pressing  on the last day (Sunday) will confirm the boost time slot and whole line will be highlighted again.
6. Press  to exit the BOOST TIMER screen.

```
BOOST TIMER
Start Dur Days
07:30 1h30 MTWTF--
08:00 0h15 MTWTF--
12:00 0h00 -----SS
17:00 0h00 -----SS
```

```
BOOST TIMER
Start Dur Days
07:30 1h30 MTWTF--
08:00 0h15 MTWTF--
12:00 0h00 -----SS
17:00 0h00 -----SS
```

## Economy Tariff Boosting

Boosting only when economy rate electricity is available can be achieved in one of three ways:

1. By setting the boost timer to coincide with the economy tariff times. This option should be used only if the electricity meter is a dual-rate meter (modern meters usually are).
2. Boost only at set times AND if economy rate electric is available.
3. Automatically boost whenever the economy tariff rate electricity is available, regardless of boost times\*

\*Options 2 and 3 are available only when using the eSense input.

For option 1, the eSense Input in the Advanced menu should be set to Boost Timer Enable.

With the Boost Timer Enable function set, the BOOST TIMER screen will include an extra column (see screenshot). The e can be toggled on/off, if e is present, the boost will activate only when the boost times are valid and the economy rate tariff is available.

Alternatively the eSense input can be used to activate the boost whenever the economy tariff rate electricity is available, regardless of boost times (option 2). To do this, the eSense Input option in the Advanced menu should be set to Boost. When using this option, the Boost Timer is not needed.

```
BOOST TIMER
Start Dur Days
e 07:30 1h30 MTWTF--
- 08:00 0h15 MTWTF--
- 12:00 0h00 -----SS
- 17:00 0h00 -----SS
```

## Boost Time Conflicts

If one or more boost times conflict, the boost will follow the latest time or longest duration.

## Lock Function

zappi can be locked from unauthorised operation. The Lock Function requires a pin number to be entered before the unit can be operated.

The lock can be set to be active

- Only when the EV is plugged in.
- Only when the EV is unplugged.
- All the time.

The settings for the Lock Function can be found in the **Other Settings/Lock Function** menu option.

Lock Function Setting	Description
EV plugged	The Lock Function is active when the EV is plugged in, preventing tampering with the charge session or changing any settings
EV unplugged	The Lock Function is active when the EV is disconnected, preventing unauthorised charging
Timeout	The time before the Lock Function automatically reactivates after being unlocked
Lock Code	This is the current lock code and is five digits from (1 to 4), it can be changed here
Auto Hide	If set, this will hide the main display of the zappi to keep the power readings private
Force Socket Lock (on/off)	This option allows an EV charge cable to be permanently locked into the socket on the zappi. This only applies to the untethered version of the zappi and is provided so you can safely leave your cable plugged into the zappi even if your EV is elsewhere – effectively turning the untethered zappi into a tethered unit.

Note: To set the lock so that it is always active make sure that both the EV plugged and EV unplugged options are selected.

For untethered units, the charging cable is locked into the socket outlet when zappi is connected to an EV if

- a PIN code has not been set or
- the PIN code has been set and the unit has been unlocked by the user.

In all cases the plug is unlocked if zappi detects a fault or the power supply to the zappi is switched off.

## Menus Main Menu

Main Menu Options		Description	
Charge Log...	Today...	Log of charge sessions	
	Yesterday...		
	Week...		
	Month...		
	Year...		
	Total...		
	Custom Date...		
Event Log...	Today...	Log of events	
	Yesterday...		
	Week...		
	Custom Date...		
Readings...	READINGS 1/4	Status: Mode:	Current status and charging mode of the unit
		Exporting: Importing:	Power being exported or imported, from or to the grid respectively
		Charging:	Power level in Watts being supplied to the EV
		Pilot (PWM):	Control Pilot PWM
		Charge Current:	AC current supplied to the EV
		Unit Temp:	Internal temperature of the zappi unit
	READINGS 2/4	Voltage:	Supply voltage to the unit
		Voltage Max:	Maximum supply voltage since switch-on
		Voltage Min:	Minimum supply voltage since switch-on
		Frequency:	Grid frequency
		Exporting: Importing:	Power being exported or imported, from or to the grid respectively
	READINGS 3/4	Exporting: Importing:	Power being exported or imported, from or to the grid respectively
		Generation:	Power from the generator (if available)
		Consumption:	Power consumed by the house (if available)
		Diverted:	Total diverted power (inc. all myenergi devices)
		Charging:	Current power being supplied to the EV
		Charge Energy:	Energy supplied to EV during current charge session
		Time:	Duration of current charge session
	READINGS 4/4	Exporting: Importing:	Power being exported or imported, from or to the grid respectively
		Battery:	If an AC battery is being monitored the battery power reading is shown: Discharging (+) Charging (-)
		Britain GMT/BST	The set Time Zone
		LOC:	Local time
		UTC:	Coordinated Universal Time
Information...	INFORMATION 1/4	Status:	Status of the unit
		Serial No:	Serial number of the unit
		Firmware:	Firmware version installed in the unit
		Assembled:	Factory assembly date
		Cal Date:	Calibration changed date



Main Menu Options		Description		
		Power Fail:	Time and date of last supply failure	
	INFORMATION 2/4	Grid Sensor:	Grid current sensor source	
		Last Fault:	Last recorded fault code	
		Fault Date:	Date and time of last recorded fault code	
		Zappi 1ph Untethered Zappi 1ph Tethered Zappi 3ph Untethered Zappi 3ph Tethered	Identifies the zappi type – eg 3 phase or single phase / tethered or untethered	
	INFORMATION 3/4	Network ID:	Network information for this device when linked to other devices using myenergi radio frequency (RF) network (Only shows if connected to other devices)	
		Device Address:		
		Master Address:		
		Channel:		
		EUI:		
	INFORMATION 4/4	MNID:		
		Time:	Current time	
		Date:	Current date	
		Up Time:	Length of time passed since last switch on	
		DDL: II: LGA: MGA: DSR:	Network load control limiting information: DDL = Dynamic Device Limit (A) II = Input current (Amps) LGA = Load Group Limit Active (Y/N) MGA = Monitor Group Active (Y/N) DSR = Demand Side Response Active (Watts and time to live) <i>See Load Balancing / Current Limiting (page 37)</i>	
Linked Devices Info...	DEVICES PWR NOW		Power currently being drawn by the linked devices	
	DEVICES PWR ALLOT		Available power allotted to the linked devices	
	DEVICES PWR MAX		Maximum power that can be used by each device	
	DEVICES PWR MIN		Minimum power that can be used by each device <i>See Linking Devices (p24) for more details about linked devices</i>	
	DEVICES MISC		Further information about power allocation of linked devices: Total Allotted = Total power allotted to all devices Total Loads = Power consumed by all devices Surplus Power = Unallocated power O/D Power = Total power over-drawn by devices Export Timer = Delay before surplus is allocated	
Charge Settings...	ECO+ Settings...	Min Green Level:	ECO+ charge mode settings. See <i>Charging Modes</i> page 11	
		Start/Stop Delay:		
	Manual Boost...		Manual Boost settings. See <i>Manual Boost</i> page 11	
	Smart Boost...		Smart Boost settings. See <i>Smart Boost</i> page 12	
	Boost Timer...		Programmable boost times. See <i>Boost Timer</i> page 14	
	Default Mode:		Can be set to "FAST / ECO / ECO+ / MEM" (MEM stands for memory, i.e. last set mode before zappi reset)	
Settings...	Time & Date...	Time:	Set current time in 24 hour format	
		Date:	Set date in Format (see below)	
		Format:	Sets the date format	
		Auto DST:	Automatic Daylight Saving Time adjustment	
		Zone:	Set zone for Daylight Saving Time	
		Update from Cloud:	Sets time automatically providing a hub is connected. If set to "ON" the time and date cannot be adjusted manually.	
	Display & Sound...	Language...		Set language for the main screen and menus
		Icons...	Generation:	Generation icon can be sun or wind

Main Menu Options		Description
	Monitoring:	If there is no generation on-site then generation monitoring can be switched off and the icon will not be shown on the main screen.
	Backlight...	Set the duration the display backlight remains on after a button press
	Contrast...	Set the display contrast
	Set Buzzer:	Switches ON or OFF the buzzer for button presses and mode changes
Lock Function...	EV plugged:	Lock is active only when EV is plugged in
	EV unplugged:	Lock is active only when EV is unplugged
	Timeout:	Length of time for the lock to reactivate after unlocking
	Lock Code:	The lock code can be changed here
	Auto Hide:	Hide the main screen when zappi is locked
	Force Socket Lock:	If set to "ON" the socket is locked all times – see <i>Lock Function</i> (page 15)
Advanced...	Advanced menu and settings (passcode protected) Default passcode: 0 0 0 0	

## Advanced Menu

Advanced Menu Options		Description	
Supply Grid...	Phase: (single phase) Phase Rotation: (three phase)	Set the supply phase to use for this device – see <i>Advanced Settings</i> (page 20) for more information	
	Device Limit:	Set the maximum available supply current to be drawn by the zappi – see <i>Advanced Settings</i> page 20 for more information	
	Export Margin:	Minimum level of export power which is maintained when zappi is diverting surplus power – see <i>Advanced Settings</i> page 20 for more information	
	Grid Limit:	Maximum grid import power limit. When charging, the charge power is reduced to keep import below this level. This also applies when boosting – see <i>Advanced Settings</i> page 20 for more information	
	Battery:	Sets the mode for managing power when a battery system is present in the installation. See <i>Battery Storage Systems</i> (page 37) for more information.	
	Net Phases:	When zappi imports and exports across phases allowing surplus power from one phase to be used on a different phase. – see <i>Advanced Settings</i> (page 20) for more information.	
Linked Devices...	Devices...	Other myenergi devices can be wirelessly linked, this shows connected devices and their priorities. Settings for some devices are made here - see <i>Linking Devices</i> (page 24)	
	Pairing Mode...	Puts this zappi in pairing mode so it can be linked to another device - see <i>Linking Devices</i> (page 24)	
	Channel... RF Channel:	Sets the radio frequency channel number used when linking other devices - see <i>Linking Devices</i> (page 24)	
	Set Master	Sets the zappi device to be master (✓ is shown) or slave - see <i>Linking Devices</i> (page 24)	
	Reset Settings...	Clear all linked device settings - see <i>Linking Devices</i> (page 24)	
CT Config...	CTINT:	Internal CT, used to configure a group limit. See <i>Load Balancing / Current Limiting</i> (page 37) for details.	
	CT1:	Set the function of CT1 input - see <i>CT Config</i> (page 21) for more details.	
	CT2:	Set the function of CT2 input - see <i>CT Config</i> (page 21) for more details.	
	CT3:	Set the function of CT3 input - see <i>CT Config</i> (page 21) for more details.	
eSense Input...	Disabled	eSense input is disabled	
	Boost	If the eSense input is live, zappi will boost the charge – see <i>eSense</i> page 23	
	Boost Timer Enable	zappi will boost the charge if eSense is live AND the boost timer is set to operate at that time - see <i>eSense</i> page 23	
Compatibility Mode...	Active:	When set to “on” the zappi will adapt to EV's with poor power factor	
	Min PWM:	Controls the Pilot PWM minimum limit.	
	Power Factor:	When Active is “on” the measured power factor must be better than this set value to enable lower charging current set by Min PWM	
	End Charge Delay:	Charge Complete status is delayed by this time to allow access to the vehicle without starting a new charge session	
	Infinite PWM:	Keeps zappi ready to restart charge after charge is complete – this is needed on some EV's when the user wants to preheat the vehicle in morning	
Menu Passcode...		The code required to access the Advanced menu	
System...	Restore Settings...	Erase Config	Restore the configuration to factory default
		Erase Data	Clear all data from memory
		Erase ALL	Restore configuration to factory default and erase all data
		Confirm	Confirm restore options and re-boot device
	Download Firmware...		Downloads latest firmware from hub
	Bootloader...		Enter Bootloader mode

## Configuration Settings

All settings are described in the *Main Menu* section, however, the more commonly altered settings are described in more detail below.

### Time & Date

The date and time are used for the Boost Timer and the savings calculations and therefore should be set correctly.

In the event of a power-cut, and providing you have a hub and have set the zappi to “set from cloud” the zappi will update the time and date automatically so when power is restored the clock will not need to be reset, if no hub is connected the zappi will keep track of the date / time for approx 48 hours.

Time is always in 24-hour format but the date format can be changed.

zappi will automatically adjust the clock for Daylight Savings Time (DST) as long as Auto DST is enabled and the correct time zone is selected.

### Advanced Settings

The **Advanced Settings** menu is passcode protected.

The default passcode is **0 0 0 0** although it can be changed with the **Passcode** menu option.

### Supply Grid - Phase

The **Phase** setting is only used when installing a single phase zappi onto a 3-phase supply.

It should be set to match the phase number that the zappi is wired to so that the power measurements are correct and that the zappi responds to the correct phase when using the harvi wireless sensor.

See *Three-Phase Systems* (page 37) and *Supply Grid – Net Phases* (page 21) for more information.

### Supply Grid – Device Limit

Sets the maximum current that the zappi will draw (including when boosting and FAST mode). This is useful if the supply current is limited, for instance, if zappi is connected on a 16A circuit instead of a 32A.

### Supply Grid – Grid Limit

Sets the limit that can be drawn from the grid connection (i.e. the maximum import current or the main fuse rating).

**Example:** A property may have a grid supply limit of only 65A, several appliances are on, the property is consuming 12kW (52A) to supply these appliances and the user wants to charge in FAST mode. Without the **Grid Limit** set, the total consumption would exceed the allowed import current and trip the supply or blow a fuse. However, with a **Grid Limit** setting of 60A, zappi would temporarily limit the charging current to 8A (about 1.8kW) and the maximum allowed import current would not be exceeded.

### Supply Grid – Battery

If the property has a static AC battery system installed, it's possible to get the zappi to work in harmony with the system, provided a CT has been installed to monitor the battery inverter. See *Battery Storage Systems* (page 37) for more information about battery storage systems.

The table below details the different settings for working with an AC coupled battery storage system:

Setting	Function description
None	There is no battery system installed.
Limit to Gen	Will limit the output of the zappi (except when boosting), to prevent unwanted draining of an AC coupled battery system. This setting does not require a CT to monitor the battery, but does need a CT to monitor the solar/wind generation. <b>Note:</b> This setting is to support legacy installations – it is preferable to install a CT to monitor the battery and use one of the settings below.
Avoid Drain	Stops the zappi (or other linked myenergi devices) draining the battery when using surplus power from the solar or wind generator.
Avoid Charge	Effectively allows the zappi (or other linked myenergi devices) to take priority over the battery when charging from solar or wind generation.
Avoid Both	Provides both of the above functions.

## Supply Grid – Net Phases

When enabled, all readings from 3-phase myenergi devices and harvi units configured as 3-phase, will be netted. This means that surplus generation on ANY phase will be considered available for consumption on ANY other phase. See *Three-Phase Systems* (page 37) for more details about myenergi devices on 3-phase supplies.

## Supply Grid – Export Margin

This sets a minimum level of export power which is maintained when zappi is charging in ECO or ECO+ modes. Normally **Export Margin** would be set to 0W (zero Watts) and all of the available surplus will be used to charge the vehicle, however, it may be desired to have a minimum export level at all times.

## CT Config

The 3 CT inputs should be configured depending on the connected CT sensors. The internal CT which measures the output current also has some settings. **Note:** These settings are the same when using CTs with the harvi device, however, they are set via the **Linked Devices** menu rather than the **CT Config** menu.

**Important:** There must be **only one Grid CT** set (per phase) for the whole installation.

**Note:** On the single phase zappi only the first two CT's can be used. CT3 is for three phase current measurement only

CT	Description
CTIL	This is the internal CT which measures the output (charging) current of the zappi.
CT1	CT1 input.
CT2	CT2 input.
CT3	CT3 input (3-phase zappi only)

CT Type	Description
None	No CT connected.
Grid	Grid CT monitors the import and export power of the property, this is main control CT and there must only be one Grid CT set for each phase.
Generation Only	Monitors Solar PV or Wind generation.
Storage Only	Monitors a device that can 'store' energy (e.g. a third-party energy diverter) and enables the zappi to take priority over it. The power used by the third-party device is considered as surplus power unless the device is intentionally using grid power (i.e. it is boosting).

# Configuration Settings

CT Type	Description
	The CT should be installed on the Live supply cable feeding the diverter, with the arrow pointing away from it.
Gen & Battery	Monitors Solar PV or Wind generation that is combined with a DC-coupled battery.
Monitor	Monitors any load, for example a washing machine or the lighting circuit. This setting can also be used to limit current drawn by myenergi devices on a particular circuit which includes other loads. See <i>Load Balancing / Current Limiting</i> (page 37) for more details.
AC Battery	Used to monitor an AC-coupled battery. With this setting it's possible to manage the distribution of surplus energy between the battery and the zappi (including myenergi devices). The <b>Battery</b> setting in the <b>Supply Grid</b> menu is used to configure how the zappi will operate alongside the battery system. See <i>Battery Storage Systems</i> (page 37) for more information. The CT should be installed on the Live supply cable of the battery inverter/charger, with the arrow pointing away from it.

## CT Groups

CTs can be put in groups so that their readings are netted. For example, you might want to monitor two solar PV systems and see the total generation on the display. Use **Group** in the **CT Config** menu to set which group the CT should be in.

**Note:** Different CT Types cannot be in the same group, the group names make this clear. Only the first 4 groups can be used for current limiting, see **Group Limits** below.

## Group Limits

Current limits can be set for certain CT Groups. When a **Group Limit** is set the myenergi devices in the group will limit the power they draw to keep within the set limit.

Group limits should be set only on the *master* device. See *Linking Devices* (p24) for details about *master* devices.

It is possible to use more than one group limit type (e.g. IL1 with MN1, so that there are two conditions for limiting).

Some examples of how to set up the group limits are described in the table below

Group Limit example	Additional CT installed	CT config (all devices)
Limit current drawn by two zappi devices that are on the same 32A supply.	None; only the internal CTs are used.	CTIL Type: Internal Group: IL1 Group Limit: 32A
Limit current drawn by an zappi device that is fed from a 32A supply which is also feeding another appliance (e.g. a tumble dryer).	One CT is clipped around Live of the 32A supply and wired to CT2 of the zappi.	CT2 Type: Monitor Group: MN1 Group Limit: 32A
Limit current drawn by two zappi devices that are in a garage which is fed from a 40A supply. A washing machine and dryer are also in the garage.	One CT is clipped around Live of the 40A supply to the garage and wired to CT2 of one of the zappi units. <b>Note:</b> The other zappi does not need to have a CT connected, but it will still need to have a CT input configured to be in the same Monitor group.	CT2 Type: Monitor Group: MN1 Group Limit: 40A

## eSense

The eSense input can be configured to automatically activate a Boost during ECO or ECO+ charging, whenever economy tariff electricity is available. The eSense input must be wired to a circuit which is live during the economy tariff times for this to function. See *eSense Input (economy tariff)* page 31 for wiring details.

eSense Setting	Description
Disabled	eSense input is ignored
Boost	If the eSense input is live, zappi will boost the charge
Boost Timer Enable	zappi will boost the charge if eSense is live AND the boost timer is set to operate at that time. see <i>Economy Tariff Boosting</i> page 14

# Configuration Settings

---

## Linking Devices

Up to six myenergi devices can be wirelessly linked together. By linking devices, you can use more of your own energy or have more control and visibility. Devices available now are:

- eddi** A microgeneration energy diverter that uses surplus power to heat water or rooms rather than exporting to the grid.
- zappi** An eco-smart electric vehicle charge point that can use surplus power to charge the car.
- harvi** A self-powered wireless sensor that can be used along with myenergi load controlling devices such as eddi and zappi. It is able to detect grid import/export conditions as well as generation power and send this information wirelessly to devices such as the eddi or zappi, this can greatly simplify installation.
- hub** The link between your myenergi devices and the internet, allowing remote monitoring and control via a mobile App.

## Master & Slave Devices



When two or more myenergi devices are wirelessly linked, one device will act as the '*master*' device. This device will control the other '*slave*' devices. Some settings can only be changed on the master device, e.g. **Grid Limit** and **Net Phases**.

Use the **Set Master** function in the **Advanced Settings/Linked Devices** menu to set which device should be master. It's a good idea to choose the device that is the most convenient to access should you wish to change settings.

 Note that **harvi** and **hub** will only pair with the device which is set as the master

## Pairing Devices

Devices are 'paired' by selecting **Pairing Mode** on each device (one device must be set to *master*).

1. On the *slave* unit, select **Pairing Mode** from the **Advanced Settings/Linked Devices** menu or by pressing the **pair** button if the device is a **harvi** or **hub**.
2. Now select **Pairing Mode** on the *master* device.
3. You will now see the **SEARCHING FOR SLAVES** screen and **zappi** will be searching for other devices which are on the same channel and are in **Pairing Mode**. Any devices found are listed along with their unique serial numbers.
4. Select the device you want to add by highlighting the appropriate device using the  and  buttons and then pressing  The device will then be added and the screen will return to the previous menu.
5. The **DEVICES** screen will then show, listing all the devices in the network. The recently added device will be able to be configured after the **UPDATING** message disappears.

## Channels

On rare occasions it is possible that there are other appliances operating on the same frequency which could cause interference. If it is not possible to link devices or the connection seems poor, changing the RF Channel may help. To do this make sure all devices are removed from the network by selecting **Reset Settings** in the **Linked Devices** menu and then select a different channel with the **Channel** menu option. Be sure to change the channel on the other devices before attempting to link them.

## Removing Devices

A device can be removed by selecting it from the **Devices** menu and then selecting **Remove Device**.



## Device Settings

Most device types have settings which can only be changed via the **Linked Devices** menu. For example, eddi and zappi have a settings for priority and harvi has settings to configure its CT inputs (see *Device Priorities* page 25).

The device settings are accessed through the **Linked Devices** menu; select **Devices** then select the appropriate device and press (+) to bring up the devices' settings screen. Refer to the relevant devices' instruction document for more information regarding the actual device settings.

**Note:** After a device has been paired you will have to wait a few seconds for the device to update before the settings can be accessed, the screen will show **DEVICES UPDATING** when this is happening.

## Device Priorities

The priority of each, load controlling linked device, can be set from any device with a display. This enables control of how the surplus energy is shared between them. The example below shows one eddi device, two zappi devices and one harvi on the same 'network'.

Priority	Device Name	Serial Number	Status Symbol
1	eddi...	12345670	~
2	ZAPPI...	87654321	
2	zappi...	76543210	
	harvi...	24680246	?

All linked devices (1) are listed in the **DEVICES** screen, the device shown in CAPITAL letters is the device currently being viewed. The serial number of each device is shown on the right (2)

The priority is shown on the left of each load controlling device (3) with 1 being the highest priority. If two or more devices have equal priority, the available surplus (for that priority level) is shared equally between them.

The ~ symbol (4) indicates which device is the 'master' device which has the Grid Sensor connected to it.

If the ? symbol (5) is shown along side a device, it indicates that communication has been lost from the device.

## Linked Devices Information







The current status of all linked devices, can be viewed together in the **LINKED DEVICES INFO** screen which can be found from the **Main Menu**.

Priority	Device Name	Real-time Output Power	Status Symbol
1	eddi	3070W	~±
2	ZAPPI	4321W	±
2	zappi	1320W	±
3	eddi	170W	×
	hub		?

This screen lists all the linked devices (1) and the priority setting for each device (3) The current device is shown in CAPITAL letters. To the right of each device is the real-time output power level (2) The right side of the screen has symbols to show the status of each device (4) Refer to the table below for the meaning each symbol.

# Configuration Settings

---

-  Grid CT – the device has a Grid CT configured (there should be only one)
-  Master – the device is the controlling device in the network
-  Boost – the device is currently boosting
-  Max – the device is at maximum output power
-  Min – the device is at minimum controllable output power
-  No Load – the device is not able to use surplus power as there is no load
-  Communication problem – there is no response from the device

## Installation

- ⚠ When installing and wiring the zappi care should be taken to maintain the IP rating of the unit. Ensure that the grommets and bungs provided are fitted, the O-ring behind the cover is seated correctly and that the electricity cable is fitted using an appropriate size and type of gland.

1

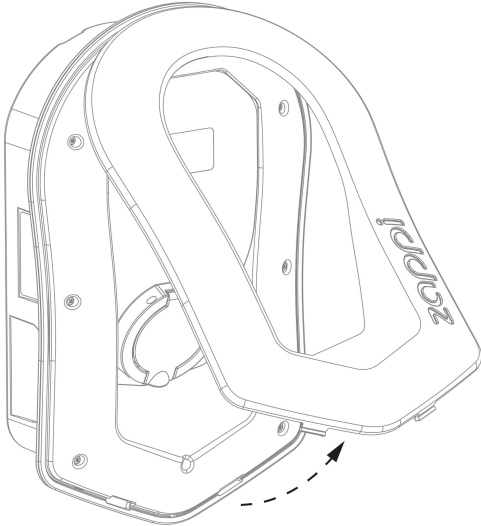

Carefully remove fascia from the zappi by pressing the 2 clips located at the bottom of unit inwards whilst pulling the fascia towards you.

2

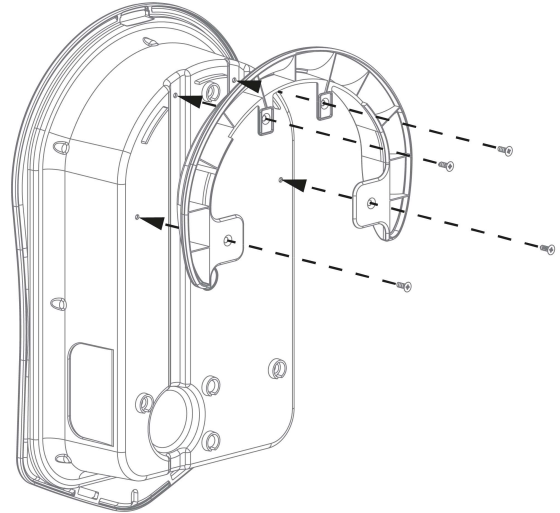

If installing a tethered zappi you must now ensure you fix the cable wall guard to the unit using the 4 screws supplied.

If installing an untethered zappi go to next step.

3

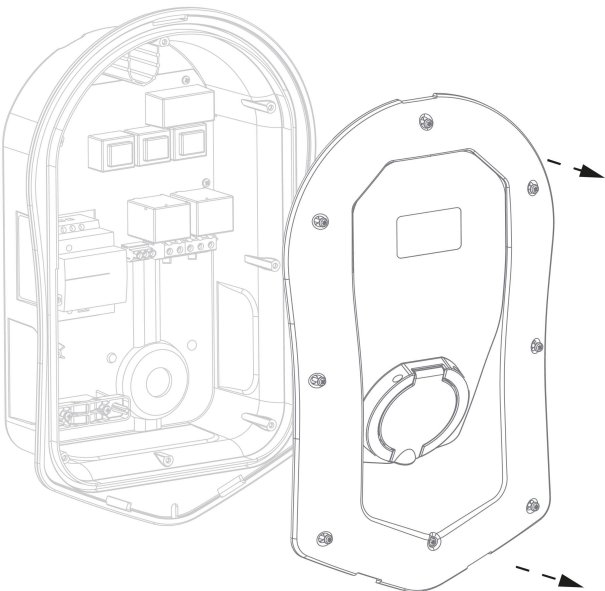

Remove all 8 screws from the enclosure and carefully lift away.

4

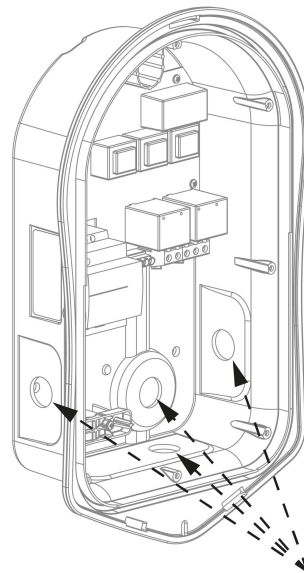

There are 4 possible cable entry positions, carefully decide which one you are going to use from the above image. You will need an IP65 or above rated cable gland. Carefully drill hole into unit to match the size of your cable gland. Attach cable gland ensuring IP rating is met.

5

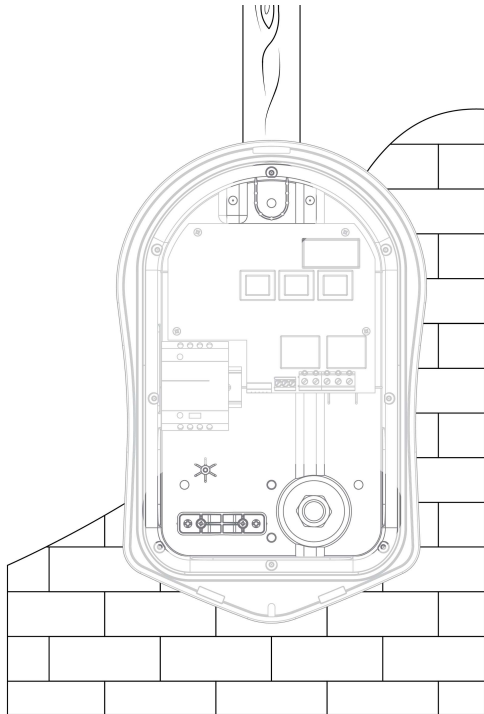

Using zappi template mark mounting holes. Use top and 2 bottom holes left/right for brick use 2 vertical holes if mounting to a stud wall or joist.

6

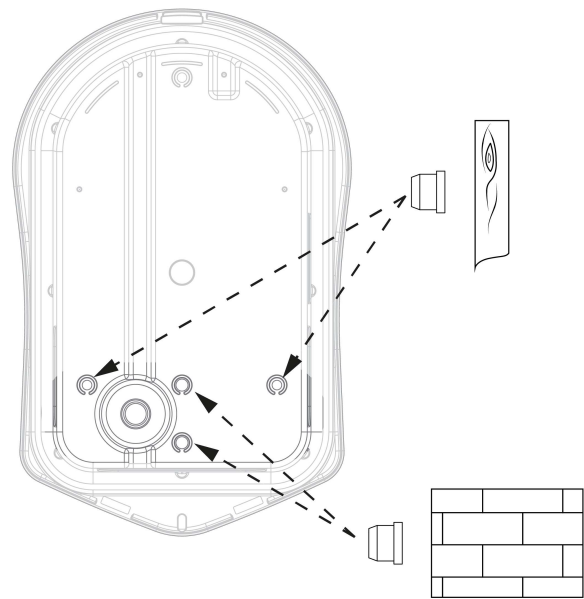

To maintain the IP rating of the unit you will need to add bungs (provided) to the holes not used.

7

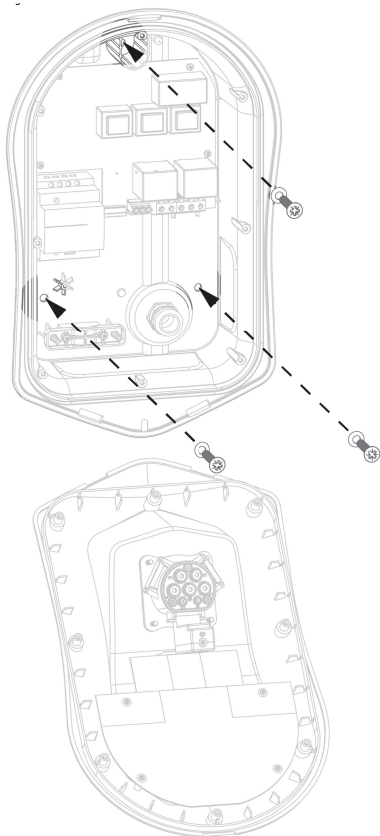

Using the fixing kit provided secure unit to the wall ensuring the grommets are used to maintain its IP integrity (Note: if using the rear cable entry remember to insert the mains cable before mounting to the wall!)

8

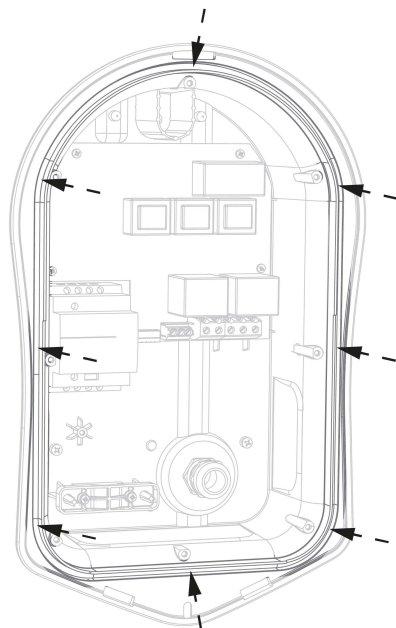

Ensure O-ring is present and sits neatly into its channel.

## Electrical Installation

### Warnings

- ⚠ **WARNING!** An electric shock can be fatal; electrical connection work may only be carried out by a competent person
- ⚠ The earth conductor must be correctly installed and reliably connected
- ⚠ This device must be equipped with an over-current protection device of maximum 32 Amps (B32)

### Supply

The single phase zappi should be connected to a 230V/240V nominal AC supply. The supply should run from a dedicated 32A circuit breaker.

The 3 phase zappi should be connected to a 400V, 4 wires 3 phase supply. The supply should run from a dedicated 3 or 4 pole 32A circuit breaker.

We recommend the use of curve B circuit breakers.

The zappi features an integral 30mA Type-A RCD with 6mA DC protection and therefore an external RCD is not required.

### Earthing

The zappi unit must be earthed in accordance with local regulations.

When installed on a PME (TNC-S) electrical system it is necessary to protect the consumer from a potential electric shock that could occur if the combined Neutral and Earth (PEN) conductor on the supply becomes damaged or disconnected.

**zappi includes an additional automatic disconnection device which satisfies the requirements of section 722.4.11.4.1(iii) of BS7671:2018 (the 18<sup>th</sup> Edition IET Wiring Regulations). This protection device**

- a) monitors the supply to identify if there is a problem with the PEN conductor and**
- b) disconnects the supply if a situation arises where the end user might suffer an electric shock**

**This means that the zappi can be installed without the need for an additional earth rod.**

However, if the customer or local regulations require that an earth rod is installed (for instance as part of a TT earthed system) then this should be connected to the dedicated terminal on the main circuit board using a ring terminal (as shown below).

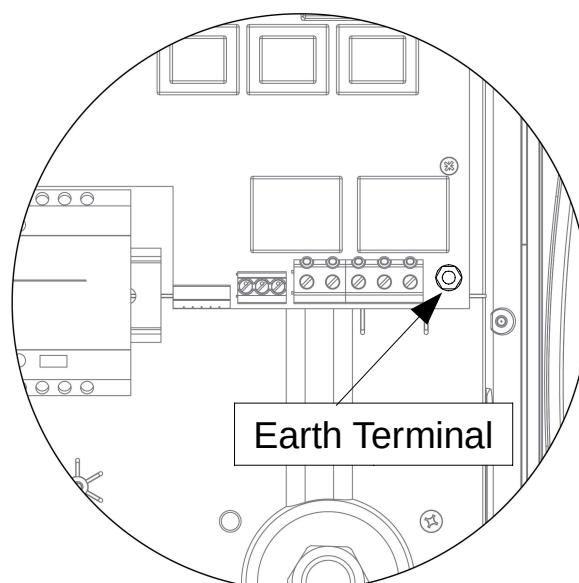

## Wiring



10mm

Insert mains cable through the installed cable gland (if not already done so) strip back outer sheath ensuring all cables reach the terminal blocks shown above (leaving a little excess) strip back all coloured cables approx 10mm, if using hard wired CT clamps now is the time to insert these to (we recommend a specialist cable gland that can accommodate multiple cables whilst still maintaining IP integrity).

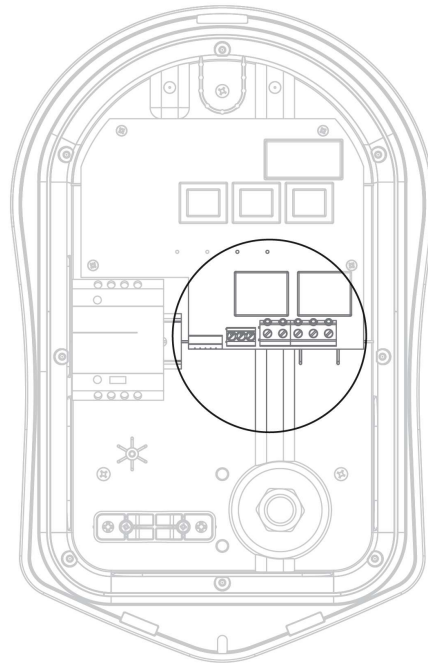

## Single Phase Wiring

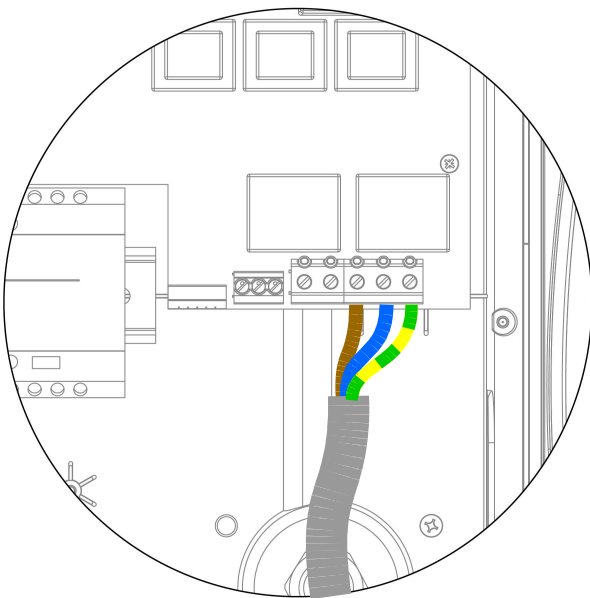

For single-phase installations without the need for hardwiring an external CT please follow the above diagram

**Earth = Green / Yellow cable**

**Neutral = Blue cable**

**Live (L1) = Brown cable**

The recommended torque setting for the electrical terminals is **1.2Nm**

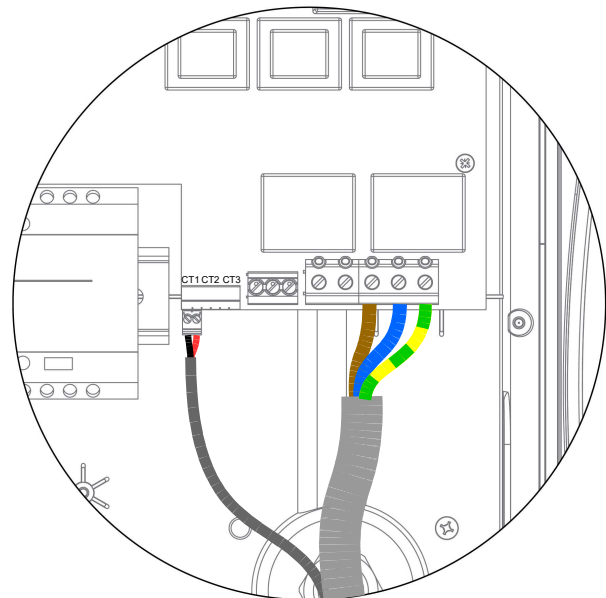

For single phase installations where 1 or 2 external / additional CT's are required, please follow the above diagram to connect the CT's using the extra 2 CT terminals in the same way if required.

**Positive (+) = Red Negative (-) Black**

For more details on CT installation and connection see *CT Sensor Installation* (Page 33)

## Three Phase Wiring

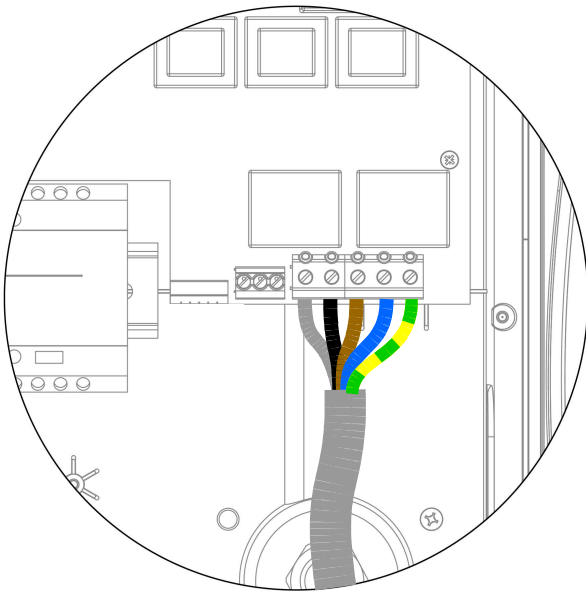

For 3 phase installations without the need for hardwiring an external CT please use the above diagram.

**Earth = Green / Yellow cable**

**Neutral = Blue cable**

**Live (L1) = Brown, Live (L2) = Black, Live (L3) = Grey**

*The recommended torque setting for the electrical terminals is 1.2Nm*

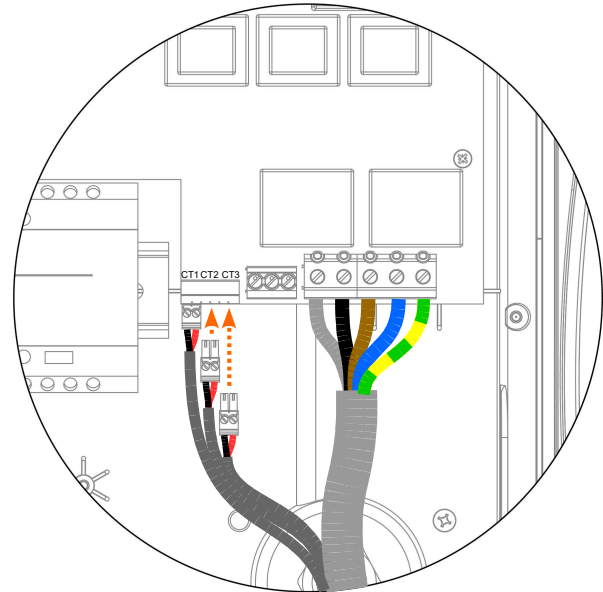

For 3 phase installations with the need for 1 or more external / additional CT's please use the above diagram.

**Positive (+) = Red Negative (-) Black**

For more details on CT installation and connection see *CT Sensor Installation* (Page 33)

## eSense Input (economy tariff)

zappi has an input which can be used to sense the availability of economy tariff electricity, this can be used to automatically boost the charge when in ECO or ECO+ charging modes.

The eSENSE input is electrically isolated and effectively draws no current so the cable size is not important. An AC voltage between 100V and 260V across the L and N terminals of the eSENSE input cause the economy tariff symbol **E** to be shown on the main screen. The eSENSE Earth terminal is not required to be connected if you do not want to use this feature or do not have an economy tariff.

See *eSense* on page 23 for details of how to configure the eSENSE input.

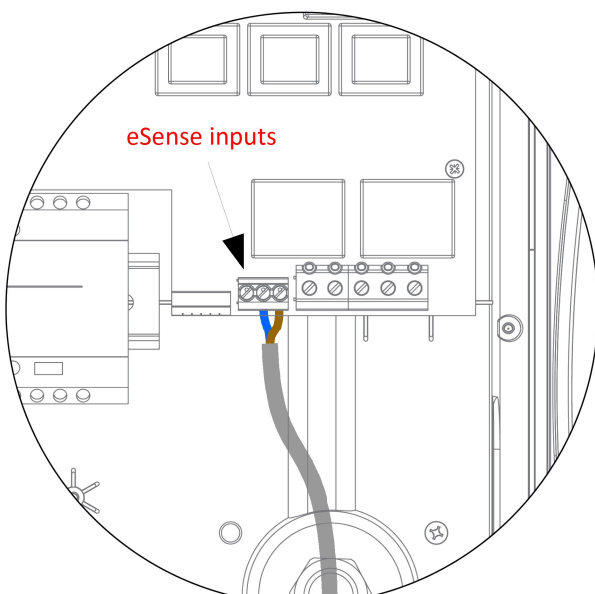

Connect the eSense cables using the opposite diagram

**Neutral = Blue cable**

**Live (L1) = Brown cable**

There is no need to earth the eSense cable although an earth terminal is available in the zappi if the cable used has an earth wire.

Wiring Overview Diagram

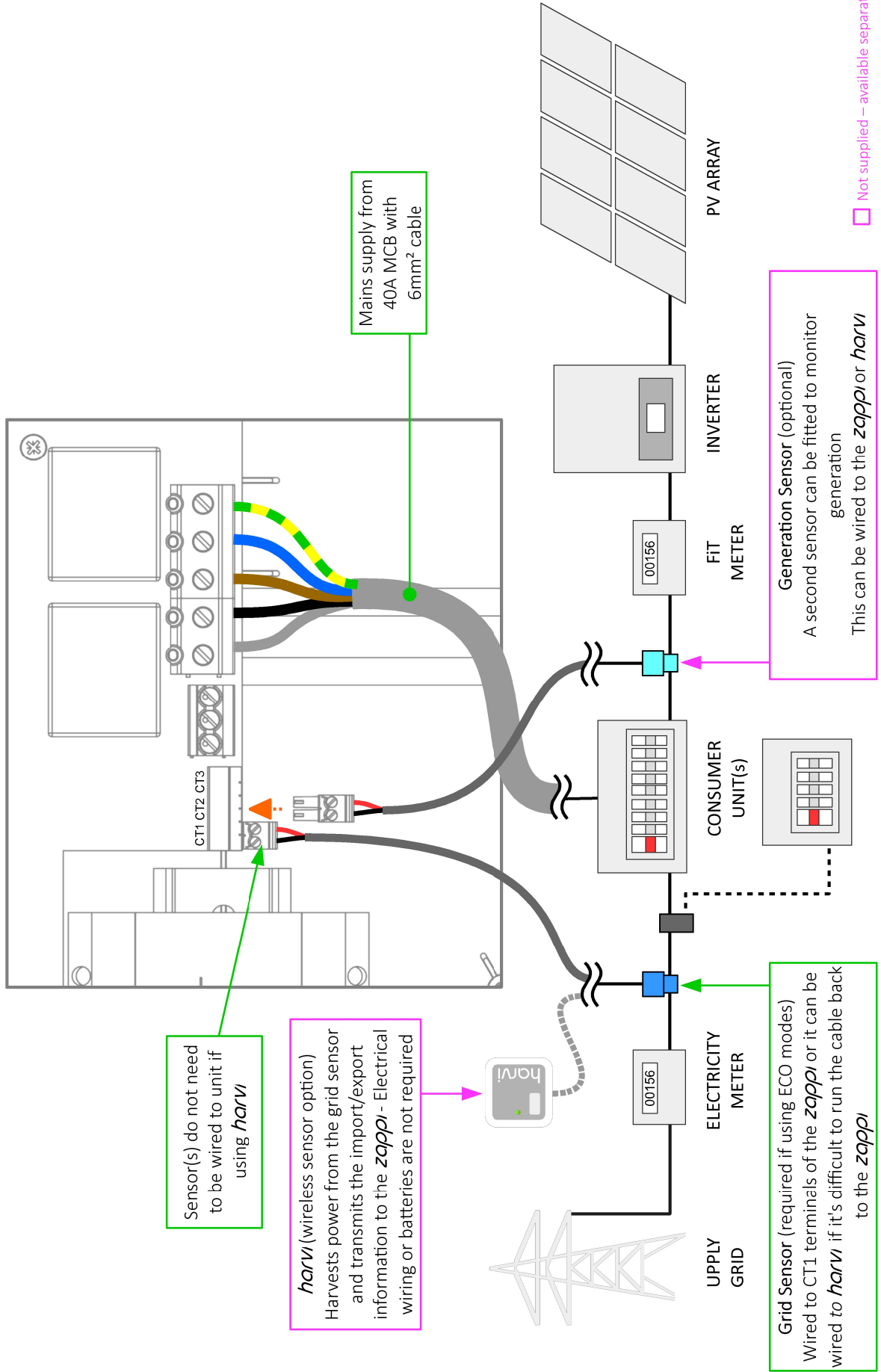



## CT Sensor Installation

Current Transformers (CTs) are used to measure current at various places of the installation. For example, the Grid connection point, the solar/wind inverter or a static battery system.

Installation of a CT to monitor the Grid connection point is required for ECO modes, Other CTs are optional and can be purchased separately. The number and location of CTs used within an installation will vary according to the devices installed and the user requirements.

CTs can be wired to any myenergi device with CT inputs (e.g. eddi, zappi or harvi). This enables very flexible installation as the CT can be wired to the nearest device. **Note:** The harvi device can be used (wirelessly) if it is not practical to connect any CT to the eddi or zappi.

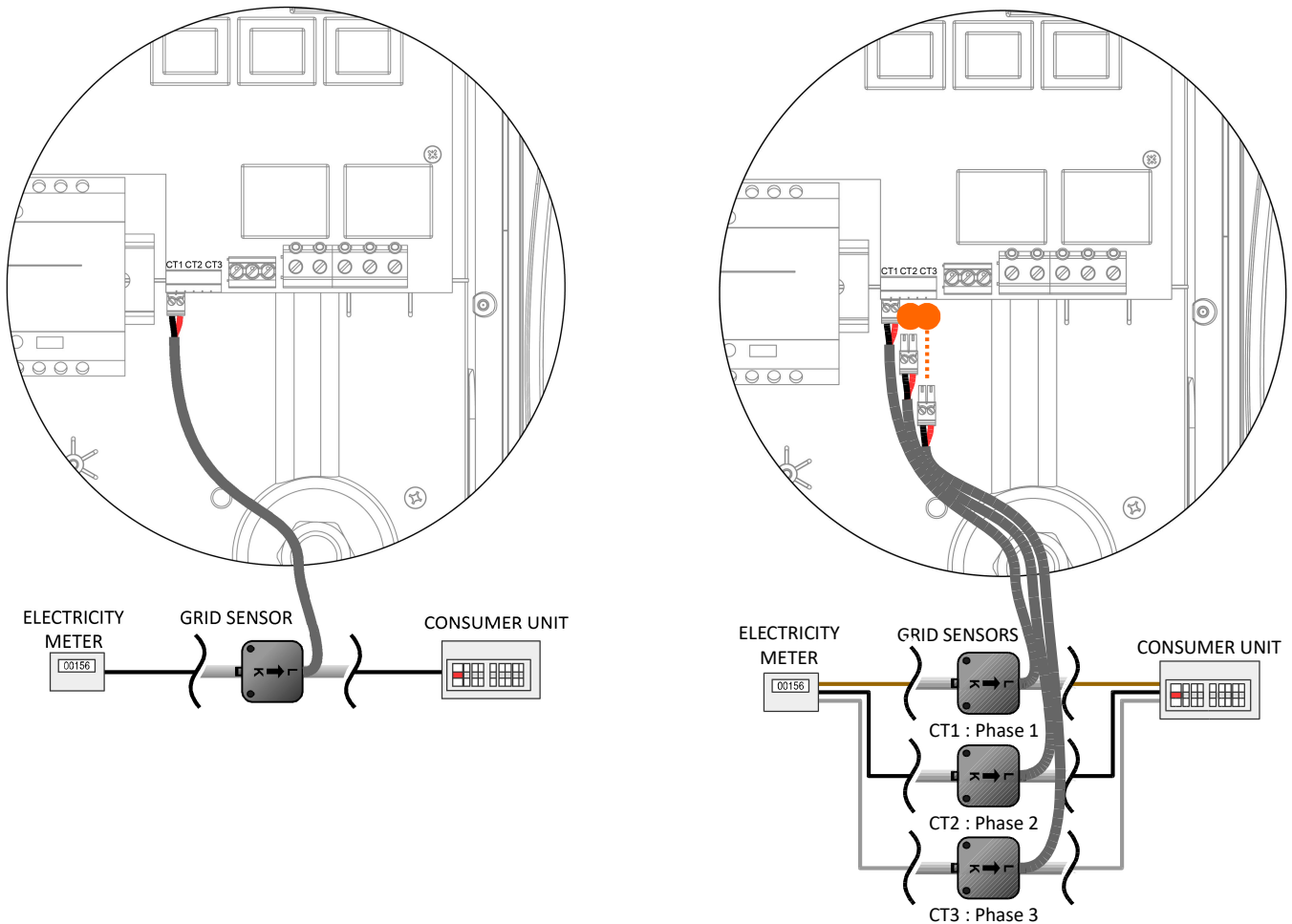

**SINGLE PHASE:** A CT clamp must be placed around the live meter tail as shown above with the arrow pointing towards the consumer unit.

(Note: the clamp can be placed on the neutral tail however the direction of the arrow shown above will need to be in reverse)

**3-PHASE:** When using 3-Phase in conjunction with hard-wired CT clamps, for it to work effectively you must place a CT clamp around each phase.

(Note: the Neutral cannot be used with 3 phase systems)

Once installed the CTs need to be configured, see *CT Config* (p21) for details of how to configure the CT's

If using a **single phase** system the wired CT sensor (**supplied**) ideally needs to be clipped around the live conductor leaving the meter tail with the arrow (located on the side of the CT) pointing towards the consumer unit, it is possible to use the Neutral conductor however you will need to reverse the direction of the sensor (e.g. arrow towards the meter)

# Installation

If using a **3 phase system** a CT sensor (**supplied**) needs to be clipped around each live tail.

The positioning of the Grid CT sensor is crucial, please take note of the following when deciding where best to install the sensor:

- ✓ The sensor can be connected to any myenergi device with a CT input e.g. the eddi or zappi (wired sensor) or harvi (wireless sensor).
- ✓ **ALL** of the import and exported power must be 'seen' by the sensor, be sure to install it before ANY junction box or 'Henley Block' (if necessary the CT can be fitted inside the consumer unit).
- ✓ There must be only one Grid CT per-phase for the whole installation. (There can be other CTs but only one at the grid connection point, also note CTs for third-party devices do not matter).
- ✓ The CT/s can be clipped on either the Live or Neutral cable on single-phase systems note: you can only use the Live tails on 3 phase system
- ✓ The arrow on the bottom of the CT sensor must be pointing towards the consumer unit (in the direction of grid import) if on the Live cable, or reversed if on the Neutral cable (single phase only)
- ✓ Ensure the CT is fully closed and clicks shut.
- ✓ Be sure to wire the CT the correct way round; **black [-], red [+]** otherwise import and export readings will be swapped.

## Additional CTs

There is an option to add other CT sensors (available separately) for monitoring the generation or other appliances such as battery systems or general loads. Installing a CT for the generator (PV system or wind) will allow the main screen to show the generated power and the total power consumption of all the other appliances in the property.

CTs can also be used to limit the power drawn from the supply. See *Load Balancing / Current Limiting* p37.

- ✓ Additional CTs Can be connected to any myenergi device with a CT input that is linked to the network (see *Linking Devices* p24).
- ✓ The arrow on the bottom of the sensor must be pointing in the direction of normal power flow (e.g. away from the PV inverter) if on the Live cable or reversed if on the Neutral cable.
- ✓ Ensure the sensor is fully closed and clicks shut.
- ✓ Be sure to wire the CT the correct way round; **black [-], red [+]**.

## Extending the sensor cable

If there is a need to extend the sensor cable, twisted-pair cable like CAT5 or telephone cable must be used. DO NOT use mains cable, bell wire or speaker cable. It is important to use only twisted-pair cable to maintain signal integrity. The cable can be extended up to 100m.

## Wireless CT Sensor (optional accessory)

In some cases it can be difficult or impractical to install a wired sensor. For example it may be the case that the zappi unit needs to be connected to a sub-board, rather than main consumer unit and two consumer units are in different buildings.

The solution to is to install harvi – a clever little device that enables the zappi and eddi products to be installed without using wired CT sensors for measuring the grid and or generation power; instead the CT sensor is connected to harvi.

The harvi does not need batteries or a power supply – the energy from the sensor is harvested and used to transmit the measurement signal to the zappi or eddi. This means batteries or electrical wiring are eliminated!

Up to 3 CT sensors may be used with harvi and it also supports 3-phase systems if three sensors are connected.

Refer to the harvi installation guide for details on installing and configuring harvi for your system.



## CT Golden Rules

### Grid CT

- Only ONE Grid CT per phase (check for only one ~ symbol in **Linked Devices Info**).
- Located to 'see' ALL import and ALL export current (i.e. always upstream of any junction box).
- Arrow pointing in direction of import (e.g. towards consumer unit if on Live cable).
- Must be on the same phase as the Master myenergji device.

### All other CTs

- Arrow should point towards the consumer unit.

### 3-Phase harvi CTs

- When using harvi in 3-phase mode, the CT inputs correspond to the phase number (e.g. CT1 = Phase 1).

### CT can dos

- ✓ Can be wired to ANY myenergji device in the network.
- ✓ harvi can be used to make ANY CT wireless.
- ✓ Cable can be extended up to 100m (must use twisted-pair cable e.g. one pair of CAT5). Cable can be shortened.
- ✓ Can be clipped around two or more conductors feeding appliances of the same type (e.g. two Live cables from two inverters that are on the same phase).
- ✓ Can be in close proximity to other CTs.
- ✓ Wires can be swapped around in device to reverse the direction of the readings (e.g. change import to export).
- ✓ Can be grouped with other CTs of the same type so that the power reading is summed (e.g. east and west solar Generation).
- ✓ Can be used on the Neutral conductor in a single phase installation (direction of arrow or wires must be reversed).
- ✓ Can be set to none in the zappi menu if you want to exclude the reading.

## Fitting the Cover

1

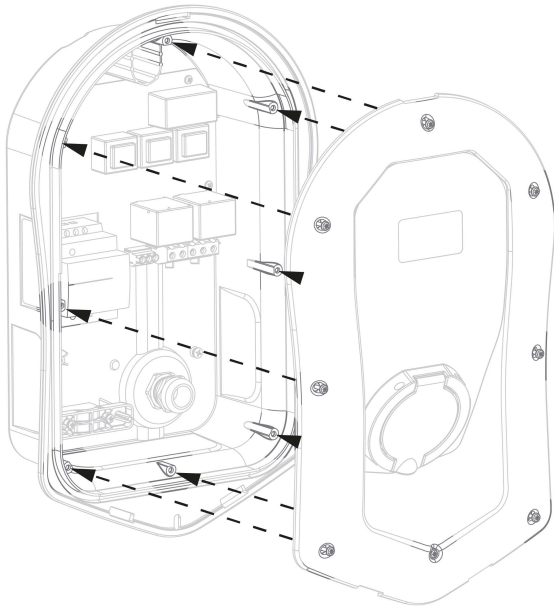

Offer cover to the enclosure ensuring all cables are neatly inside the unit.  
Ensure O-ring (seal) is firmly placed into the channel.  
Secure cover to unit using the 8 screws removed earlier (Torque setting = 1.2Nm).

2



Add fascia to the enclosure cover of the zappi as shown.

3

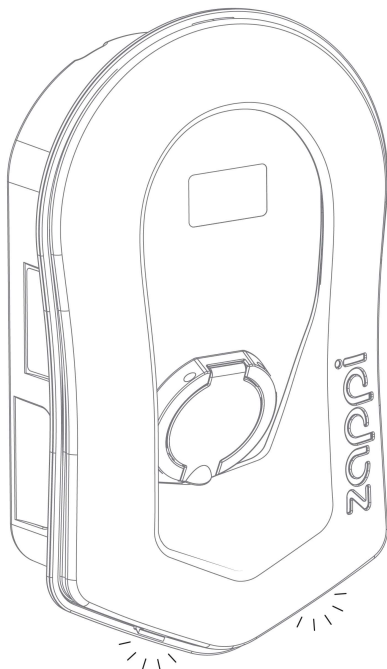

Ensure the 2 tabs at the bottom of the fascia click to indicate its securely fixed in place.

4

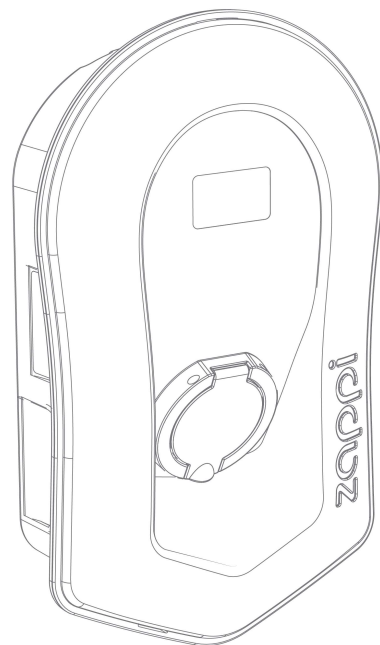

zappi is now ready for operation.

## Advanced Installation Options

### Load Balancing / Current Limiting

CTs can be also used to limit the current drawn by myenergi devices to avoid overloading circuits; this is sometimes referred to as load balancing. There are four different ways to limit current and they can be used alone or combined for more complex situations. See the table below:

Function	Operation	Example
<b>Device Limit</b>	Sets a maximum current that can be drawn by the device (e.g. zappi). The current will not be exceeded even during Boost or Fast charge.	A zappi is wired to a 20A supply (rather than a 32A). The maximum current drawn will not exceed the set limit (e.g. 20A).
<b>Grid Limit</b>	Sets the limit that can be drawn from the grid connection (i.e. the maximum import current). The zappi and any other linked myenergi device, will limit the current they draw if there is a danger of exceeding the set <b>Grid Limit</b> .	A property may have a grid supply limit of only 65A, several appliances are on and the property is consuming 12kW (52A) by other appliances and the user wants to charge in FAST mode. With a <b>Grid Limit</b> setting of 60A, zappi would temporarily limit the charging current to 8A (about 1.8kW) and the maximum allowed import current would not be exceeded.
<b>Group Limit (internal CT)</b>	Sets the combined current limit for several myenergi devices	A property has a large PV array and a swimming pool and two zappis. The supply to the zappis is only rated at 40A so to be safe a <b>Group Limit</b> of 40A is set.
<b>Group Limit (with external CT)</b>	Sets the combined current limit for several myenergi devices that are sharing a supply with another large appliance.	A zappi is installed in a garage which also has a washer and a dryer (2.5kW each). The garage has a supply of 32A coming from the main consumer unit in the house. If all appliance were on together and no limit had been set the total current would exceed the maximum supply current. By setting the <b>Group Limit</b> to 32A an overload will be avoided.

### Three-Phase Systems

If the installation supply is three-phase you can use either the 3 x CT connectors on the zappi (hard wired) or a harvi device (optional) we recommend you use one CT per phase This will allow the zappi to show the total grid import and export figures rather than just one of the phases.

If all three phases are monitored and the generation is 3-phase, it is also possible to net the export power across phases, to do this, enable **Net Phases** in the **Supply Grid** menu see *Supply Grid – Net Phases* (p21). This allows the zappi to use surplus power from any phase and not just the phase which the zappi is installed on. However, you must be sure that the electricity is metered in such a way as to allow this.

### Battery Storage Systems

#### AC coupled

Where there is an AC coupled battery storage system, there can be a conflict as both the storage system and the zappi are effectively competing to consume the surplus energy. Whilst this is not necessarily an issue, the results can be somewhat unpredictable.

There is the option to add an additional CT sensor to monitor the battery storage; this will give control as to which device has priority. This additional CT sensor should be wired to one of the CT terminals of the zappi or a harvi

device if wireless measurement is required. This CT should be clipped around the live or neutral cable of battery inverter.

During the setup process it will be necessary to change the setting for the appropriate CT to **AC Battery**; refer to *CT Config* (page 21) . Also refer to (page 20) for information on setting 'priority' of battery systems.

## DC coupled

Battery systems that charge directly from the solar array and cannot charge from AC are usually referred to as being DC coupled. This type of battery system uses the solar PV inverter to provide power from the batteries, thus it is not possible to differentiate between solar and battery power when using a CT to measure the AC current from the inverter.

Because of this limitation, there are less options for managing the surplus power with this type of battery system. However it is usually possible to effectively give priority to battery by setting an **Export Margin** in the zappi. A setting of 50W or 100W is recommend. The **Export Margin** setting is found in the **Advanced Settings/Supply Grid** menu.

## Third-Party Diverters

Some properties may have a third-party energy diverter installed and you may want the zappi to take priority (when consuming surplus power) over the diverter. This is possible by installing an extra CT to monitor the diverter.

The CT should be clipped around the Live cable of the supply feeding the diverter. The arrow on the CT should be pointing away from the diverter. Wire the CT to the nearest myenergi device or use a harvi unit if a wireless connection is needed.

Configure the CT **Type** as **Storage Only**. See *CT Config* (page 21) for details of how to configure CTs.

## Voltage Optimisers

If there is a voltage optimiser (VO) installed in the property, the CT sensor and the zappi must both be on the same side of the VO; either the incoming grid supply or the optimised supply.

## Built-in Protection

zappi has a number of protection features built into the device to make it safe and simple to install.

### RCD Protection

The RCD (Residual Current Device) will trip the output from zappi if there is an electrical fault to ground. The RCD is similar to the protective devices found in most domestic consumer units (the “fuse box”) but the standards for electric vehicle charging require additional protection for small DC leakage currents. There is no need to install an extra RCD as zappi already provides the protection required in accordance with EN 61008 (Integral 30mA Type A RCD) and EN 62955 (6mA DC protection).

If there is an electrical fault to ground and the RCD operates the zappi display will show **RCD Tripped!**

To reset the zappi, make sure that the fault has been removed and then press the  button for three seconds.

### Loss of PEN Conductor

The Protective Neutral and Earth (PEN) conductor refers to part of the electricity cable to the property. If this conductor is damaged there is a danger that the chassis of the electric vehicle being charged will become “live” and cause an electric shock. BS7671:2018 part 722.411.4.1(iii) requires that extra protection is provided to prevent an electric shock – either by fitting an extra earth electrode or through a device which detects the fault and disconnects the supply.

zappi has the protection built in (patent pending) and will disconnect the output if it detects a problem with the PEN conductor or it detects that there may be any electric current flowing through the chassis of the EV. This built in protection means that there is no need to install an extra earth electrode with the zappi.

If zappi detects a problem with the PEN conductor then the display will show **PEN Fault!**

To reset the zappi, check the continuity of the earth cable and then press the  button for three seconds.

### Loss of PE

zappi is able to measure the continuity of the protective earth conductor (the earth wire) on the supply cable. If the earth is disconnected or has a high impedance then zappi will trip and the display will show **PE not connected!**

To reset the zappi, make sure that the fault has been removed and then press the  button for three seconds.

### Welded Contact

zappi includes protection to make sure that the supply to EV is disconnected if there is a problem with the circuit breaker which turns the electric supply to the vehicle on and off. This includes a problem where the contacts on the breaker are welded together. This is a specific requirement of the Renault “Z.E. Ready” and ASEFA “EV Ready” standards (e.g. requirement for Nissan).

If zappi detects a problem with a welded contact then the display will show **RLY WELDED!**

If this happens and the fault cannot be reset by pressing the  button for three seconds then please contact myenergi technical support at [support@myenergi.uk](mailto:support@myenergi.uk).

### Over-current

If there is a problem with the equipment on the EV which charges the vehicle’s battery this may mean that too much current is drawn from the supply – This means that the zappi is not able to control the charge rate as expected and it could lead to problems with overheating or tripping of the main circuit breaker to the zappi. zappi provides additional protection in accordance with the EV Ready standard by opening it’s built in contactor and isolating the EV if it detects that vehicle is drawing more than 125% of the maximum current communicated to it by the zappi.

If zappi detects an over-current then the display will show **Over Current!**

To reset the zappi, make sure that the fault has been removed and then press the  button for three seconds

## Over and Under-voltage

zappi will also isolate the supply to the EV if it detects a problem with the electricity supply voltage. The nominal supply voltage is 230V but zappi will trip the output if the measured voltage is more than 10% above or below this level for five seconds.

The zappi display will show **Over Voltage!** or **Under Voltage!**

To reset the zappi, unplug the EV and then press the  button for three seconds.

## Thermal Limit

zappi also includes protection against overheating. If zappi gets too warm it will attempt to reduce the current being drawn by reducing the EV charge rate. If this happens you will see the  icon on the main display.

If the problem continues and the zappi's internal temperature continues to rise then it will trip the output to the EV and the display will show **Overheating!**

zappi will resume normal operation once the temperature drops.

## Setup

### Switching On

After completing and checking the wiring of the supply, the sensor(s), switch on the zappi via the circuit breaker.

zappi will start-up and the main screen will be presented after a few seconds.

If zappi has been installed alongside another zappi unit or another myenergi device, refer to *Linking Devices* (page 24) for guidance on pairing devices. Also refer to the instruction documentation for the other devices.

### Testing

Before leaving site, it is wise to perform a few checks to ensure that the sensors have been correctly installed and are functional.

1. Check that the time and date are correct and displayed at the bottom left of the main screen. If they are not present or are incorrect, set the correct time and date in the **Other Settings/Time & Date** menu option.
2. Check that the EV will charge in FAST mode.
3. Check the Grid Power reading at the top right of the main screen is showing sensible readings and the direction of power flow is as expected.
4. With the EV plugged in, switch to ECO mode charging and check that the charge power is at minimum (about 1.4kW) OR that it is 'tracking' the surplus power (i.e. the Grid Power reading is 0.0kW)
5. If a Generation Sensor has been installed, check that the generated power is shown at the top left of the main screen.

If the generation reading is missing, the most likely cause is the CT2 input is not enabled – see *CT Config* on page 21. Or, if the Grid Sensor is instead wired to a harvi ensure the device settings are set correctly – see *Device Settings* on page 25.









## Troubleshooting

Symptom	Cause	Solution
Display is blank	- There is no power to the unit	- Check for correct supply voltage at the supply screw terminals (220 - 260V AC)
In ECO+ mode, the charge does not start, the display is always showing <b>Waiting for Surplus</b> and the export power is 0W	- Grid Sensor incorrectly installed - Faulty Grid Sensor - No signal from harvi (if used)	- Check the grid sensor is connected to CT1 or CT2 terminals of the zappi or any CT input on the harvi - Check the Grid CT sensor is installed on the correct cable (see CT Sensor Installation page 33) - Check resistance of the sensor - it should be around 200 $\Omega$ when not connected (remove the sensor from the cable before testing resistance) - If using harvi, check that the CT input has been set to Grid in the harvi settings (under Devices in the zappi menu)
In ECO+ mode, the charge does not start, the display is always showing <b>Waiting for Surplus</b> , yet the export power is showing correctly	- Export Margin set too high	- Check Export Margin setting (default is 0W)
Generation power is always 0.0kW	- Generation sensor not installed	- Install generation sensor and connect to CT1 or CT2 input - Alternatively, if there is no Generation CT, the Generation and House consumption figures can be hidden on the main screen by setting CT2 Input in the Advanced Settings menu to OFF

# Troubleshooting

## Faults

If any of the following fault messages are displayed, follow the action described. However, if the problem persists, stop using zappi and call your installer or your local technical support.

Displayed Message	Description	Action
RCD Fault!	The internal Earth leakage protection has tripped.	Unplug from the EV and press and hold the  button to reset the unit.
PEN Fault!	The internal protection against the loss of the PEN conductor on the electricity supply has tripped.	Unplug the EV, make sure that the fault has been removed and hold the  button to reset the unit.
Over Current!	The EV is drawing too much current – the output is switched off.	Unplug from the EV and press and hold the  button to reset the unit.
PE not connected!	zappi has detected a problem with the main earth connection to the unit. The earth is either disconnected or the impedance of the earth connection is too high.	Unplug the EV, check the earth connection to the zappi and then hold the  button to reset the unit.
Over Voltage!	zappi has detected that the supply voltage is too high and has disconnected the EV to protect it.	Unplug the EV, make sure that the fault has been removed and hold the  button to reset the unit.
Under Voltage!	zappi has detected that the supply voltage is too low and has disconnected the EV to protect it.	Unplug the EV, make sure that the fault has been removed and hold the  button to reset the unit.
Overheating!	The zappi unit is too hot – the output is switched off.	Make sure that the zappi is properly ventilated (eg has not been covered) Charge will resume once the unit has cooled down again.
RLY WELDED!	The main relay inside the zappi has a welded contact. The secondary relay is open to make sure that the supply to the EV is isolated.	Unplug the EV, press and hold the  button to reset the unit.

If any of the above faults persist then contact your supplier or myenergi technical support at [support@myenergi.uk](mailto:support@myenergi.uk).

## Warranty

Subject to the provisions described below, this product is protected for three (3) years from the date of purchase against defects in material and workmanship.

Prior to returning any defective product to myenergi, the end customer must report the faulty product to myenergi by either emailing myenergi at [support@myenergi.uk](mailto:support@myenergi.uk) or calling myenergi on **+44 (0)333 300 1303**. If myenergi agrees that the product should be returned, it will issue a Return Merchandise Authorisation (RMA) number, the RMA must be clearly marked on the packaging of the product to be returned. myenergi may arrange collection at its discretion, otherwise the customer should return the product at their own cost.

Should the product fail to perform as described within the relevant warranted period as set out above, it will be repaired or replaced with the same or functionally equivalent product by myenergi, at its discretion, free of charge provided the end customer: (1) returns the failed product to myenergi with shipping charge prepaid, and (2) provides myenergi with proof of the original date of purchase. Returned or replacement products will be returned to the end customer with shipping charges prepaid.

Replacement products may be refurbished or contain refurbished materials. If myenergi, by its sole determination, is unable to repair or replace the defective product, it will refund the depreciated purchase price of the product.

The warranty does not apply if, in the judgement of myenergi, the product fails due to damage from shipment, handling, storage, incorrect installation, accident, inappropriate use or cleaning of the product, relocation of the product after its first installation, abuse, misuse, or if it has been used or maintained in a manner not conforming to product manual instructions, has been modified in any way, or has had any serial number or other identification markings removed or defaced.

Repair by anyone other than myenergi or an approved agent will void this warranty.

All defective products should be returned to myenergi with shipping charges prepaid, unless myenergi have arranged collection at its own cost.

Nothing in this agreement will affect the end customer's statutory rights or limit or exclude myenergi's liability for (1) death or personal injury caused by its negligence, or the negligence of its employees, agents or subcontractors (as applicable), (2) fraud or fraudulent misrepresentation; (3) defective products under the Consumer Protection Act 1987; or (4) any matter in respect of which it would be unlawful for myenergi to exclude or restrict liability.

The maximum liability of myenergi under this warranty is limited to the purchase price of the product covered by the warranty.

myenergi only supply products for resale for domestic, light commercial and private use. myenergi accept no liability to the end customer for any loss of profit, loss of business, business interruption, or loss of business opportunity.

## Product Registration

Please register your new myenergi devices at <https://myenergi.com/product-registration/>

# Technical Specifications

---

## Technical Specifications

### Performance

---

Mounting Location	Indoor or Outdoor (permanent mounting)
Charging Mode	Mode 3 (IEC 61851-1 compliant communication protocol)
Display	Graphical backlit LCD
Front LED	Multicolour, according to charge status and current
Charging Current	Single Phase units 6A to 32A (variable)
Dynamic Load Balancing	Optional setting to limit current drawn from the unit supply or the grid
Charging Profile	3 charging modes: ECO, ECO+ and FAST
Connector Type	Type 2 tethered cable (6.5m) or type 2 socket with locking system
Compliance	LVD 2014/35/EU, EMC 2014/30/EU, EN 61851-1:2017, EN 62196, EN 62955:2018, ROHS 2011/65/EU, CE Certified

### Electrical Specifications

---

Rated Power	7kW (1-ph) or 22kW (3-ph)
Rated Supply Voltage	230V AC Single Phase or 400V AC 3-Phase (+/- 10%)
Supply Frequency	50Hz
Rated Current	32A max
Standby Power Consumption	3W
Earth Leakage Protection	Integral 30mA Type A RCD (EN 61008) + 6mA DC protection (EN 62955)
Economy Tariff Sense Input	230V AC sensing (4.0kV isolated)
Wireless Interface	868 MHz (proprietary protocol) for wireless sensor and remote monitoring options
Grid Current Sensor	65A max. primary current, 16mm max. cable diameter
Supply Cable Entry	Rear / Bottom / left side / Right side

### Mechanical Specifications

---

Enclosure Dimensions	439 x 282 x 122mm
Protection Degree	IP65 (weatherproof)
Enclosure Material	ABS 6 & 3mm (UL 94 flame retardant) colours: white RAL 9016 and grey RAL 9006
Operating Temperature	-25°C to +40°C
Fixing Points	In-line vertical mounting holes
Weight	Single Phase Untethered: 3.0kg Single Phase Tethered: 5.5kg Three Phase Untethered: 3.3kg Three Phase Tethered: 7.2kg

## Technical Specifications continued

### Charging Modes

<b>ECO</b>	Charge power is continuously adjusted in response to changes in generation or power consumption elsewhere in the home. Charging will continue until the vehicle is fully charged, even if power is drawn from the grid.
<b>ECO +</b>	Charge power is continuously adjusted in response to changes in generation or power consumption elsewhere in the home. Charging will pause if there is too much imported power, continuing only when there is surplus free power available.
<b>FAST</b>	In this mode, the vehicle will be charged at maximum power. This is just like an ordinary Mode 3 charging point.

### Model Variants

Model No.	Rating	Connector	Colour
ZAPPI-207UW	7kW	Untethered	White
ZAPPI-207TW	7kW	Tethered	White
ZAPPI-207UB	7kW	Untethered	Black
ZAPPI-207TB	7kW	Tethered	Black
ZAPPI-222UW	22kW (3-Phase)	Untethered	White
ZAPPI-222TW	22kW (3-Phase)	Tethered	White
ZAPPI-222UB	22kW (3-Phase)	Untethered	Black
ZAPPI-222TB	22kW (3-Phase)	Tethered	Black

Designed to permit installations compliant with IET Wiring Regulations BS7671:2018 and the Electricity Safety, Quality, and Continuity Regulations 2002 and BS 8300:2009+A1:2010.

# The myenergi app



## The myenergi app

We have a myenergi app for iPhone and Android devices. This allows you to control and monitor your zappi and other myenergi devices.

The app is free to download and use and is available from the appropriate app store, but you will need to install the myenergi hub to connect your zappi to the internet.

Please check on our web site ([myenergi.com](http://myenergi.com)) for more details.

## The myenergi forum

We also have a very active user forum at [myenergi.info](http://myenergi.info)

This is where our customers and installers share their experiences, provide advice to each other on getting the best out of their myenergi products and share their ideas for future product development

We also post details of firmware updates on this forum and provide answers to the questions raised.

## Technical Support

If you experience any issues with your zappi during or post installation, please contact our technical support team:

support@myenergi.uk  
0333 300 1303  
8.30am – 5.30pm  
Monday – Friday



Our experienced engineers will be pleased to assist and to help solve your issues over the phone. Please contact us directly for the quickest solution.

## Introducing the myenergi eddi

 Eco-Smart Energy Diverter

eddi is an energy management system that diverts surplus power from PV or wind to a designated heating appliance (or two sequentially) such as an immersion heater.

Stop exporting energy back to the grid, install eddi and start making savings on your heating bill.

 eddi works seamlessly with other myenergi devices and utilises our proprietary VariSine™ technology to ensure compliance with worldwide power grid standards

Visit our web site <https://myenergi.com/product/eddi/> for more details.



## My Devices

Please use these pages to record the details of your myenergi devices and how they are configured

### Zappi

Date Installed: \_\_\_\_\_

Installer Name / Contact: \_\_\_\_\_

Master Device?: Y / N

CT Connections – If external CT's are connected to your zappi what are the CT's measuring?

CT1: \_\_\_\_\_ CT2: \_\_\_\_\_

CT3: \_\_\_\_\_

Installer Notes:

---

### Harvi – If installed

Serial Number: \_\_\_\_\_ Date Installed: \_\_\_\_\_

CT Connections – If external CT's are connected to your harvi what are the CT's measuring?

CT1: \_\_\_\_\_ CT2: \_\_\_\_\_

### Eddi

Serial Number: \_\_\_\_\_ Date Installed: \_\_\_\_\_

Master Device?: Y / N

CT Connections – If external CT's are connected to your eddi what are the CT's measuring?

CT1: \_\_\_\_\_ CT2: \_\_\_\_\_

This is your unique production identification

Please use the space inside the back cover of this manual to record the details of your installation inside and keep this information safe.

Make sure you register your new zappi at [www.myenergi.com/product-registraton](http://www.myenergi.com/product-registraton) and also have a look at the myenergi app



myenergi

Designed and manufactured in the UK by  
myenergi Ltd, Church View Business Park, Binbrook, Lincolnshire, LN8 6BY, UK  
T: +44 (0)333-300 1303  
E: [vibe@myenergi.uk](mailto:vibe@myenergi.uk)  
W: [myenergi.com](http://myenergi.com)