

Original MC4-Evo 2

Renewable Energy | Solar Photovoltaics

EN



Female and male cable coupler MC4-Evo 2

Female and male cable coupler as individual part (including insulating part)

PV-KBT4-EVO 2A/...

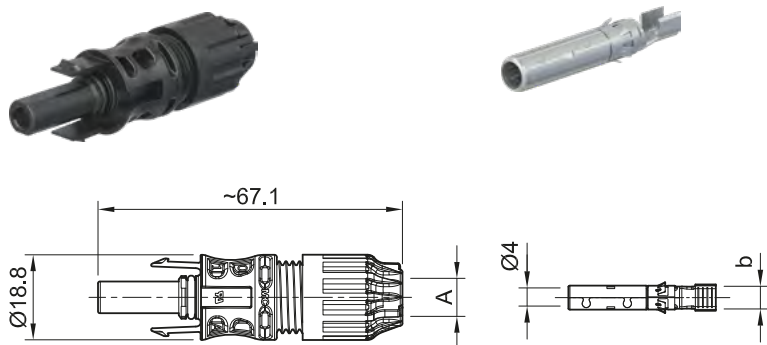

PV-KST4-EVO 2A/...

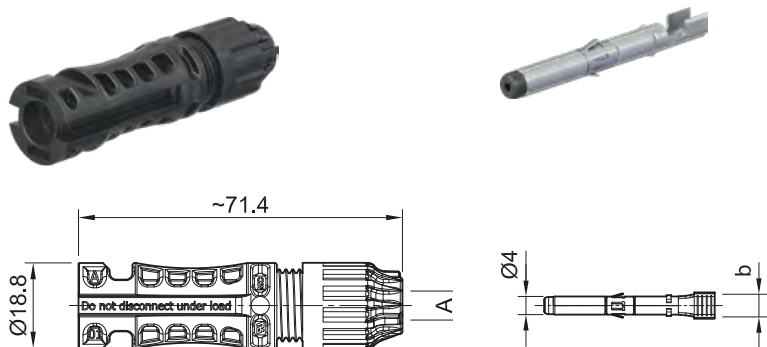

Sealing caps see catalog tools and accessories, page 21

Tools see catalog tools and accessories, page 4 – 16

www.staubli.com/re-downloads.html → English → Catalog → Tools and accessories



Assembly instructions see MA298

www.staubli.com/re-downloads.html → English → Assembly info → MA298

Internationally certified with IEC, UL, JET, cTÜVus. Approved for DC 1500 V (IEC, JET), DC 1500 V (UL) unrestricted access. MULTILAM Technology, has proven the

quality and durability several 100 million times since 2004. Suited for all climatic environments due to UV resistance, ammonia and high IP degree. Available as a field and

preassembled connector, standard crimping tools can be used. Mating compatibility with MC4 connector family.

Technical data	
Connector system	Ø 4 mm
Ambient temperature range	-40 °C ... +85 °C (IEC/UL)
Transportation/storage temperature range	-30 °C/+60 °C
Transportation/storage relative humidity	< 70 %
Upper limiting temperature	115 °C (IEC)
Degree of protection, mated	IP65/IP68 (1 m, 1 h)
Degree of protection, unmated	IP2X
Overvoltage category	III
Contact resistance of plug connectors	< 0.2 mΩ
Locking system	Locking type
Class (IEC)	II
Contact system	MULTILAM
Type of termination	Crimping
Warning	Do not disconnect under load
Contact material	Copper, tin plated
Insulation material	PA
Flame class	UL94-V0
Ammonia resistance (TÜV Rheinland certified acc. to 2 PFG 1911/03.2011)	Q60139020-0001
TÜV-Rheinland certified according to IEC 62852:2014+Amd.1:2020	R 60127169
UL recognized component in accordance with UL6703	E343181
Maximum altitude above sea level for operation	5000 m
Temperature Level according to IEC TS 63126	Level 2

Female and male cable coupler MC4-Evo 2

Female and male cable coupler as individual part (including insulating part)

Order No.	Type	Socket	Plug	Outer diameter of cable	Width of crimp opening	IEC 62852			UL 6703			Approvals	
						mm ²	DC V	A	AWG	DC V	A	TÜV Rheinland	UR
32.0310P0001	PV-KBT4-EVO 2A/2.5I	x		4.7-6.4	4	2.5	1500	39				x	x
									14	1500	30		
32.0311P0001	PV-KST4-EVO 2A/2.5I		x	4.7-6.4	4	2.5	1500	39				x	x
									14	1500	30		
32.0312P0001	PV-KBT4-EVO 2A/2.5X	x		5.9-7.3	4	2.5	1500	39				x	x
									14	1500	30		
32.0313P0001	PV-KST4-EVO 2A/2.5X		x	5.9-7.3	4	2.5	1500	39				x	x
									14	1500	30		
32.0314P0001	PV-KBT4-EVO 2A/2.5II	x		6.4-8.4	4	2.5	1500	39				x	x
									14	1500	30		
32.0315P0001	PV-KST4-EVO 2A/2.5II		x	6.4-8.4	4	2.5	1500	39				x	x
									14	1500	30		
32.0316P0001	PV-KBT4-EVO 2A/6I	x		4.7-6.4	5.8	4	1500	45				x	x
						6	1500	53					
									12	1500	35		
									10	1500	50		
32.0317P0001	PV-KST4-EVO 2A/6I		x	4.7-6.4	5.8	4	1500	45				x	x
						6	1500	53					
									12	1500	35		
									10	1500	50		
32.0318P0001	PV-KBT4-EVO 2A/6X	x		5.9-7.3	5.8	4	1500	45				x	x
						6	1500	53					
									12	1500	35		
									10	1500	50		
32.0319P0001	PV-KST4-EVO 2A/6X		x	5.9-7.3	5.8	4	1500	45				x	x
						6	1500	53					
									12	1500	35		
									10	1500	50		

Note:

For detailed information concerning the suitable cable gland range, please consult MA298.

Order No.	Type	Socket	Plug	Outer diameter of cable	Width of crimp opening	IEC 62852			UL 6703			Approvals	
						mm ²	DC V	A	AWG	DC V	A	TÜV Rheinland	UR
32.0320P0001	PV-KBT4-EVO 2A/6II	x		6.4-8.4	5.8	4	1500	45				x	x
						6	1500	53					
									12	1500	35		
									10	1500	50		
32.0321P0001	PV-KST4-EVO 2A/6II		x	6.4-8.4	5.8	4	1500	45				x	x
						6	1500	53					
									12	1500	35		
									10	1500	50		
32.0322P0001	PV-KBT4-EVO 2A/10X	x		5.9-7.3	6.5	10	1500	69				x	x
									8	1500	70		
32.0323P0001	PV-KST4-EVO 2A/10X		x	5.9-7.3	6.5	10	1500	69				x	x
									8	1500	70		
32.0324P0001	PV-KBT4-EVO 2A/10II	x		6.4-8.4	6.5	10	1500	69				x	x
									8	1500	70		
32.0325P0001	PV-KST4-EVO 2A/10II		x	6.4-8.4	6.5	10	1500	69				x	x
									8	1500	70		

Female and male cable coupler MC4-Evo 2

Contacts on carrier band (including insulating part)

PV-KBT4-EVO 2A/...

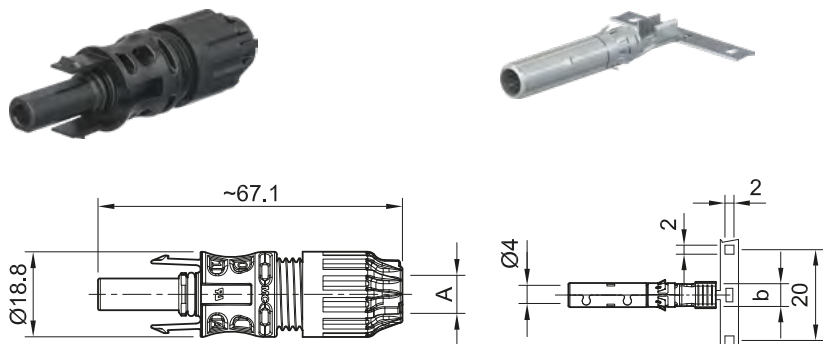

PV-KST4-EVO 2A/...

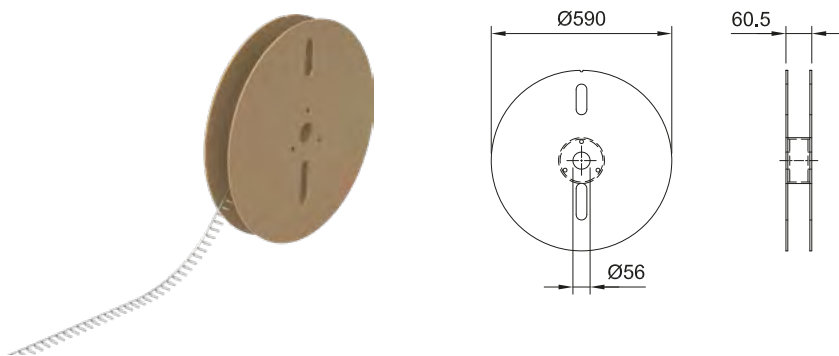
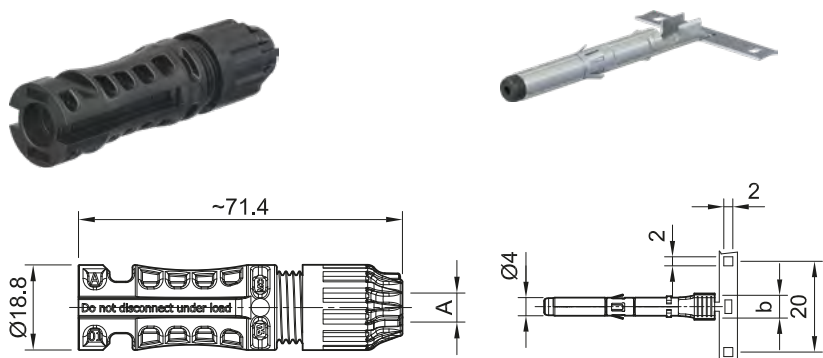

Sealing caps see catalog tools and accessories, page 21

Tools see catalog tools and accessories, page 4 – 16

www.staubli.com/re-downloads.html → English → Catalog → Tools and accessories



Assembly instructions see MA298

www.staubli.com/re-downloads.html → English → Assembly info → MA298

Internationally certified with IEC, UL, JET, cTÜVus. Approved for DC 1500 V (IEC, JET), DC 1500 V (UL) unrestricted access. MULTILAM Technology has proven the qual-

ity and durability several 100 million times since 2004. Suited for all climatic environments due to UV resistance, ammonia and high IP degree. Available as a field and pre-

assembled connector; standard crimping tools can be used. Mating compatibility with MC4 connector family.

Technical data	
Connector system	Ø 4 mm
Ambient temperature range	-40 °C ... +85 °C (IEC) -40 °C ... +90 °C (UL)
Transportation/storage temperature range	-30 °C/+60 °C
Transportation/storage relative humidity	< 70 %
Upper limiting temperature	115 °C
Degree of protection, mated	IP65/IP68 (1 m, 1 h)
Degree of protection, unmated	IP2X
Overvoltage category	III
Contact resistance of plug connectors	< 0.2 mΩ
Locking system	Locking type
Class (IEC)	II
Contact system	MULTILAM
Type of termination	Crimping
Warning	Do not disconnect under load
Contact material	Copper, tin plated
Insulation material	PA
Flame class	UL94-V0
Ammonia resistance (TÜV Rheinland certified acc. to 2 PFG 1911/03.2011)	Q60139020-0001
TÜV-Rheinland certified according to IEC 62852:2014+Amd.1:2020	R 60127169
UL recognized component in accordance with UL6703	E343181
Maximum altitude above sea level for operation	5000 m
Temperature Level according to IEC TS 63126	Level 2

Female and male cable coupler MC4-Evo 2

Contacts on carrier band (including insulating part)

Order No.	Type	Socket	Plug	Outer diameter of cable	Width of crimp opening	IEC 62852			UL 6703			Contacts per reel	Approvals	
						mm ²	DC V	A	AWG	DC V	A		TÜV Rheinland	UR
				A (mm)	b (mm)									
32.0310P2000	PV-KBT4-EVO 2A/2.5I	x		4.7-6.4	4.0	2.5	1500	39				2000	x	x
									14	1500	30			
32.0311P2000	PV-KST4-EVO 2A/2.5I		x	4.7-6.4	4.0	2.5	1500	39				2000	x	x
									14	1500	30			
32.0312P2000	PV-KBT4-EVO 2A/2.5X	x		5.9-7.3	4.0	2.5	1500	39				2000	x	x
									14	1500	30			
32.0313P2000	PV-KST4-EVO 2A/2.5X		x	5.9-7.3	4.0	2.5	1500	39				2000	x	x
									14	1500	30			
32.0314P2000	PV-KBT4-EVO 2A/2.5II	x		6.4-8.4	4.0	2.5	1500	39				2000	x	x
									14	1500	30			
32.0315P2000	PV-KST4-EVO 2A/2.5II		x	6.4-8.4	4.0	2.5	1500	39				2000	x	x
									14	1500	30			
32.0316P2000	PV-KBT4-EVO 2A/6I	x		4.7-6.4	5.8	4	1500	45				2000	x	x
						6	1500	53						
									12	1500	35			
									10	1500	50			
32.0317P2000	PV-KST4-EVO 2A/6I		x	4.7-6.4	5.8	4	1500	45				2000	x	x
						6	1500	53						
									12	1500	35			
									10	1500	50			
32.0318P2000	PV-KBT4-EVO 2A/6X	x		5.9-7.3	5.8	4	1500	45				2000	x	x
						6	1500	53						
									12	1500	35			
									10	1500	50			
32.0319P2000	PV-KST4-EVO 2A/6X		x	5.9-7.3	5.8	4	1500	45				2000	x	x
						6	1500	53						
									12	1500	35			
									10	1500	50			

Note:

For more detailed information concerning the suitable cable gland range, please consult MA298.

Order No.	Type	Socket	Plug	Outer diameter of cable	Width of crimp opening	IEC 62852			UL 6703			Contacts per reel	Approvals	
						mm ²	DC V	A	AWG	DC V	A		TÜV Rheinland	UR
				A (mm)	b (mm)									
32.0320P2000	PV-KBT4-EVO 2A/6II	x		6.4-8.4	5.8	4	1500	45				2000	x	x
						6	1500	53						
									12	1500	35			
									10	1500	50			
32.0321P2000	PV-KST4-EVO 2A/6II		x	6.4-8.4	5.8	4	1500	45				2000	x	x
						6	1500	53						
									12	1500	35			
									10	1500	50			
32.0322P1500	PV-KBT4-EVO 2A/10X	x		5.9-7.3	6.5	10	1500	69				1500	x	x
									8	1500	70			
32.0323P1500	PV-KST4-EVO 2A/10X		x	5.9-7.3	6.5	10	1500	69				1500	x	x
									8	1500	70			
32.0324P1500	PV-KBT4-EVO 2A/10II	x		6.4-8.4	6.5	10	1500	69				1500	x	x
									8	1500	70			
32.0325P1500	PV-KST4-EVO 2A/10II		x	6.4-8.4	6.5	10	1500	69				1500	x	x
									8	1500	70			

Female and male panel receptacle MC4-Evo 2

Female and male panel receptacles as individual part (including insulating part)

PV-ADB4-EVO 2A/...

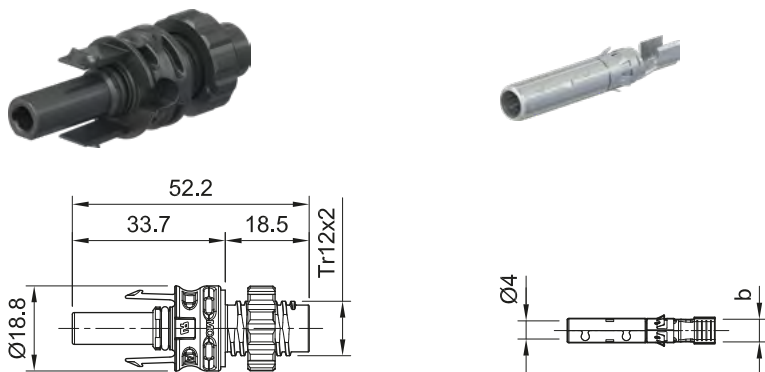

PV-ADS4-EVO 2A/...

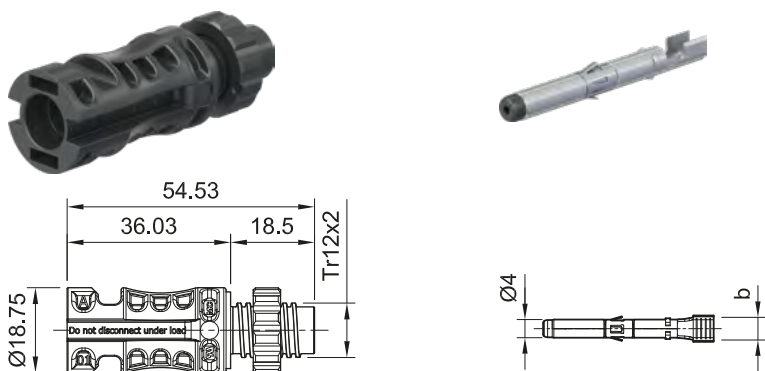

Sealing caps see catalog tools and accessories, page 21

Tools see catalog tools and accessories, page 4 – 16

www.staubli.com/re-downloads.html → English → Catalog → Tools and accessories



Assembly instructions see MA713

www.staubli.com/re-downloads.html → English → Assembly info → MA713

MC4-Evo 2 panel-receptacle connectors are the interface between the inverter or the distributor housing and string. Assembly directly via the threads or in the perforated plate with the plastic nut (contained in

scope of delivery). Thanks to the D-shape thread the connection is secured against twisting. For 1500 DC V (IEC), 1500 DC V (UL) approved without constraints. Degree of protection IP65/IP68 (1 m, 1 h) guarantees

highest connection safety. Fast and clean connection. Plug compatible with the original MC4 plug connector family. With preassembled flat seal.

Technical data	
Connector system	Ø 4 mm
Ambient temperature range	-40 °C...+85 °C (IEC) -40 °C...+90 °C (UL)
Upper limiting temperature	115 °C
Degree of protection, mated	IP65/IP68 (1 m, 1 h)
Degree of protection, unmated	IP2X
Overvoltage category	III
Locking system	Locking type
Contact system	MULTILAM
Type of termination	Crimping
Contact material	Copper, tin plated
Insulation material	PA
Flame class	UL94-V0
TÜV Rheinland certified according to IEC 62852:2014+Amd.1:2020	R 60127171
UL recognized component in accordance with UL6703	E343181
Maximum altitude above sea level for operation	5000 m
Temperature level according to IEC TS 63126	Level 2

Order No.	Type	Socket	Plug	Width of crimp opening	IEC 62852			UL 6703			Approvals	
					mm ²	DC V	A	AWG	DC V	A	TÜV Rheinland	UR
32.0344P0001	PV-ADB4-EVO 2A/2.5	x		4.0	2.5	1500	32				x	x
								14	1500	30		
32.0345P0001	PV-ADS4-EVO 2A/2.5		x	4.0	2.5	1500	32				x	x
								14	1500	30		
32.0346P0001	PV-ADB4-EVO 2A/6	x		5.8	4	1500	42				x	x
					6	1500	47					
								12	1500	35		
								10	1500	50		
32.0347P0001	PV-ADS4-EVO 2A/6		x	5.8	4	1500	42				x	x
					6	1500	47					
								12	1500	35		
								10	1500	50		
32.0352P0001	PV-ADB4-EVO 2A/10	x		6.5	10	1500	62				x	x
								8	1500	70		
32.0353P0001	PV-ADS4-EVO 2A/10		x	6.5	10	1500	62				x	x
								8	1500	70		

Note:

For more detailed information concerning the suitable cable gland range, please consult MA713

Note

When using panel receptacles in housings (e.g. inverter maker) confirm that the minimum plastic wall thickness shall be between 1 mm and 6 mm; on metal housings, wall thickness shall be between 1 mm and 4 mm. In case of wall thickness undercut or exceedance, the panel receptacle usage in the end-application has to be verified by the installer.

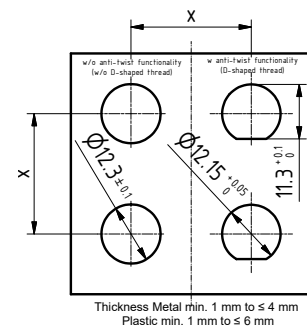

Female and male panel receptacle MC4-Evo 2

Contacts on carrier band (including insulating part)

PV-ADB4-EVO 2A/...

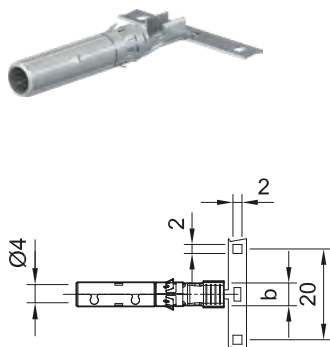
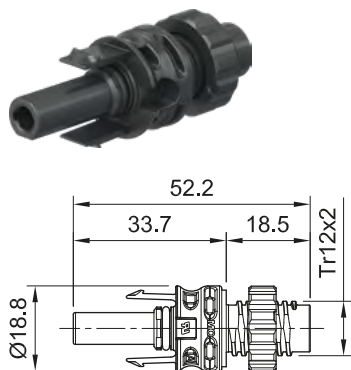

PV-ADS4-EVO 2A/...

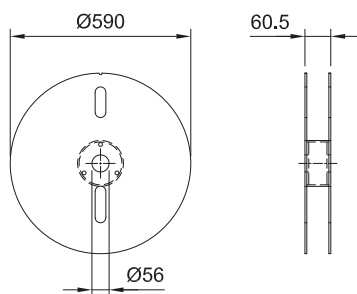
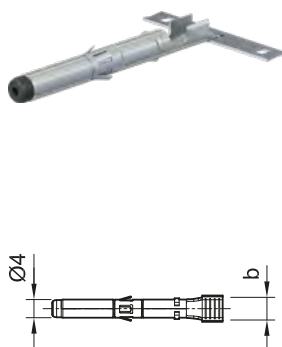

Sealing caps see catalog tools and accessories, page 21

Tools see catalog tools and accessories, page 4 – 16

www.staubli.com/re-downloads.html → English → Catalog → Tools and accessories



Assembly instructions see MA713

www.staubli.com/re-downloads.html → English → Assembly info → MA713

MC4-Evo 2 panel-receptacle connectors are the interface between the inverter or the distributor housing and string. Assembly directly via the threads or in the perforated plate with the plastic nut (contained in

scope of delivery). Thanks to the D-shape thread the connection is secured against twisting. For 1500 DC V(IEC), 1500 DC V (UL) approved without constraints. Degree of protection IP65/IP68 (1 m, 1 h) guarantees

highest connection safety. Fast and clean connection. Plug compatible with the original MC4 plug connector family. With preassembled flat seal.

Technical data	
Connector system	Ø 4 mm
Ambient temperature range	-40 °C...+85 °C (IEC) -40 °C...+90 °C (UL)
Upper limiting temperature	115 °C
Degree of protection, mated	IP65/IP68 (1 m, 1 h)
Degree of protection, unmated	IP2X
Overvoltage category	III
Locking system	Locking type
Contact system	MULTILAM
Type of termination	Crimping
Contact material	Copper, tin plated
Insulation material	PA
Flame class	UL94-V0
TÜV Rheinland certified according to IEC 62852:2014+Amd.1:2020	R 60127171
UL recognized component in accordance with UL6703	E343181
Maximum altitude above sea level for operation	5000 m
Temperature level according to IEC TS 63126	Level 2

Order No.	Type	Socket	Plug	Width of crimp opening b (mm)	IEC 62852			UL 6703			Contacts per reel	Approvals	
					mm ²	DC V	A	AWG	DC V	A		TÜV Rheinland	UR
32.0344P2000	PV-ADB4-EVO 2A/2.5	x		4.0	2.5	1500	32				2000	x	x
								14	1500	30			
32.0345P2000	PV-ADS4-EVO 2A/2.5		x	4.0	2.5	1500	32				2000	x	x
								14	1500	30			
32.0346P2000	PV-ADB4-EVO 2A/6	x		5.8	4	1500	42				2000	x	x
					6	1500	47						
								12	1500	35			
								10	1500	50			
32.0347P2000	PV-ADS4-EVO 2A/6		x	5.8	4	1500	42				2000	x	x
					6	1500	47						
								12	1500	35			
								10	1500	50			
32.0352P1500	PV-ADB4-EVO 2A/10	x		6.5	10	1500	62				1500	x	x
								8	1500	70			
32.0353P1500	PV-ADS4-EVO 2A/10		x	6.5	10	1500	62				1500	x	x
								8	1500	70			

Note:

For more detailed information concerning the suitable cable gland range, please consult MA713

Note

When using panel receptacles in housings (e.g. inverter maker) confirm that the minimum plastic wall thickness shall be between 1 mm and 6 mm; on metal housings, wall thickness shall be between 1 mm and 4 mm. In case of wall thickness undercut or exceedance, the panel receptacle usage in the end-application has to be verified by the installer.

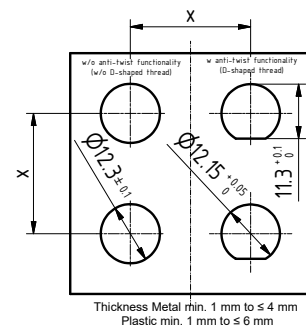



● Stäubli Units ○ Representatives/Agents

Global presence of the Stäubli Group

www.staubli.com