

Hi-MO 6

Explorer

LR5-54HTH 420~440M

- Suitable for Distribution Market
- Simple design embodies modern style
- Better energy generation performance
- High-quality module guarantees long-term reliability



15-year Warranty for
Materials and Processing



25-year Warranty for Extra
Linear Power Output

Complete System and Product Certifications

IEC 61215, IEC 61730, UL 61730

ISO9001:2015: ISO Quality Management System

ISO14001: 2015: ISO Environment Management System

ISO45001: 2018: Occupational Health and Safety

IEC62941: Guideline for module design qualification and type approval

LONGI



22.5%
MAX MODULE
EFFICIENCY

0~3%
POWER
TOLERANCE

<1.5%
FIRST YEAR
POWER DEGRADATION

0.40%
YEAR 2-25
POWER DEGRADATION

Additional Value

25-Year Power Warranty

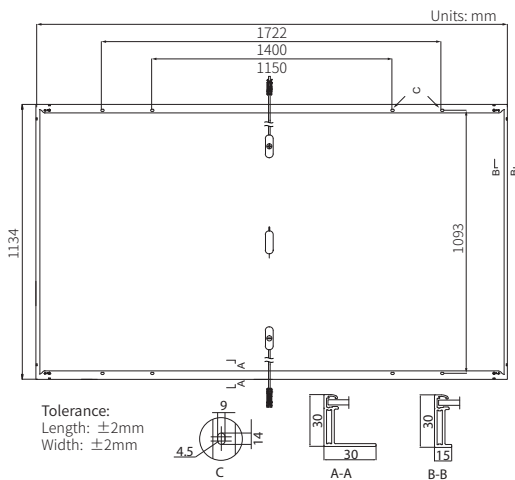
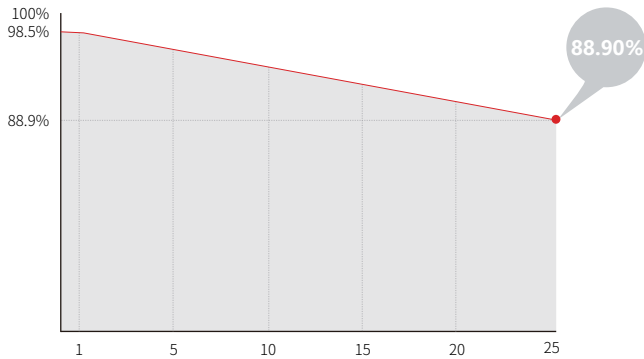

Mechanical Parameters

Cell Orientation	108 (6×18)
Junction Box	IP68
Output Cable	4mm ² , ± 1200 mm length can be customized
Glass	Single glass, 3.2mm coated tempered glass
Frame	Anodized aluminum alloy frame
Weight	20.8kg
Dimension	1722×1134×30mm
Packaging	36pcs per pallet / 216pcs per 20' GP / 936pcs per 40' HC

Electrical Characteristics

STC : AM1.5 1000W/m² 25°C NOCT : AM1.5 800W/m² 20°C 1m/s Test uncertainty for Pmax: $\pm 3\%$

Module Type	LR5-54HTH-420M		LR5-54HTH-425M		LR5-54HTH-430M		LR5-54HTH-435M		LR5-54HTH-440M	
	STC	NOCT	STC	NOCT	STC	NOCT	STC	NOCT	STC	NOCT
Maximum Power (Pmax/W)	420	314	425	318	430	321	435	325	440	329
Open Circuit Voltage (Voc/V)	38.73	36.36	38.93	36.55	39.13	36.74	39.33	36.93	39.53	37.11
Short Circuit Current (Isc/A)	14.00	11.31	14.07	11.36	14.15	11.43	14.22	11.49	14.30	11.55
Voltage at Maximum Power (Vmp/V)	32.44	29.60	32.64	29.78	32.84	29.97	33.04	30.15	33.24	30.33
Current at Maximum Power (Imp/A)	12.95	10.60	13.03	10.67	13.10	10.72	13.17	10.78	13.24	10.85
Module Efficiency(%)	21.5		21.8		22.0		22.3		22.5	

Operating Parameters

Operational Temperature	-40°C ~ +85°C
Power Output Tolerance	0 ~ 3%
Voc and Isc Tolerance	$\pm 3\%$
Maximum System Voltage	DC1500V (IEC/UL)
Maximum Series Fuse Rating	25A
Nominal Operating Cell Temperature	45 ± 2 °C
Protection Class	Class II
Fire Rating	UL type 1 or 2 IEC Class C

Mechanical Loading

Front Side Maximum Static Loading	5400Pa
Rear Side Maximum Static Loading	2400Pa
Hailstone Test	25mm Hailstone at the speed of 23m/s

Temperature Ratings (STC)

Temperature Coefficient of Isc	+0.050%/°C
Temperature Coefficient of Voc	-0.230%/°C
Temperature Coefficient of Pmax	-0.290%/°C